



# Device circuit breakers

Electronic, thermomagnetic, and thermal circuit breakers

# High-level system availability

Increasing demand for high quality and efficiency in production is leading to the construction of increasingly complex systems. At the same time, the requirements for safety and availability are tightening because the failure of one machine or major system parts can result in significant costs. Having a well-planned safety concept for individual circuits and end devices throughout the entire system is a significant contribution toward operational safety. This also includes selecting a sufficiently powerful power supply and suitable protective devices.



1

## Electronic circuit breakers

High functionality, low space requirement and flexible use. With intelligent analysis and signaling of interference, electronic circuit breakers are a perfect way to monitor the system states. They protect system components and switched-mode power supply units against failure.

More information starting on page 8

2

## Thermal-magnetic device circuit breakers

With proven simplicity and suitable for a wide range of applications. Thermal-magnetic circuit breakers feature a thermal and a magnetic tripping mechanism. This means that they trip faster than thermal fuses in case of short circuit. They provide ideal protection against overload and short-circuit currents.

More information starting on page 36

## Find out more with the web code

For detailed information, use the web codes provided in this brochure. Simply enter # and the four-digit number in the search field on our website.

**i** Web code: #1234 (example)

Or use the direct link:  
[phoenixcontact.net/webcode/#1234](https://phoenixcontact.net/webcode/#1234)



3

### Thermal device circuit breakers

Compact, optimal basic protection against overload. Thermal circuit breakers can be switched on again immediately after tripping. Replacement, as is the case with fuses, is therefore not necessary.

More information starting on page 46

## Contents

Device circuit breakers in comparison	4
Electronic circuit breakers	8
Circuit breaker system	12
Single-channel circuit breakers – adjustable and narrow	20
Single-channel circuit breakers – pluggable and customizable	24
Multi-channel circuit breakers – compact with tool-free adjustability	28
Multi-channel circuit breakers – highly functional and space-saving	30
Thermal-magnetic device circuit breakers	36
Pluggable and customizable circuit breakers	38
One-piece and modular, extendable circuit breakers	44
Thermal device circuit breakers	46
Space-saving basic protection	48
Basic protection for AC and DC applications	50

# Device circuit breakers in comparison

## Advantages through selective device protection

An electrical system consists of many components that must work together in concert. Many loads are supplied by the same power supply in this type of arrangement. This creates dependencies that are important and critical to system availability. Unscheduled machine downtime must be avoided at all costs. Therefore, it is very important to ensure that if there is a fault, any loads and circuits not involved remain unaffected by the fault. The supply voltage must likewise be maintained in the event of a fault. This is the only way to ensure smooth operation.

Using device circuit breakers minimizes potential damage and downtimes by separately protecting individual devices or device groups with device circuit breakers. In this way, end devices are optimally protected against damage or destruction. System parts that are not in the affected circuit continue to operate without interruption to the extent that the overall process allows it.

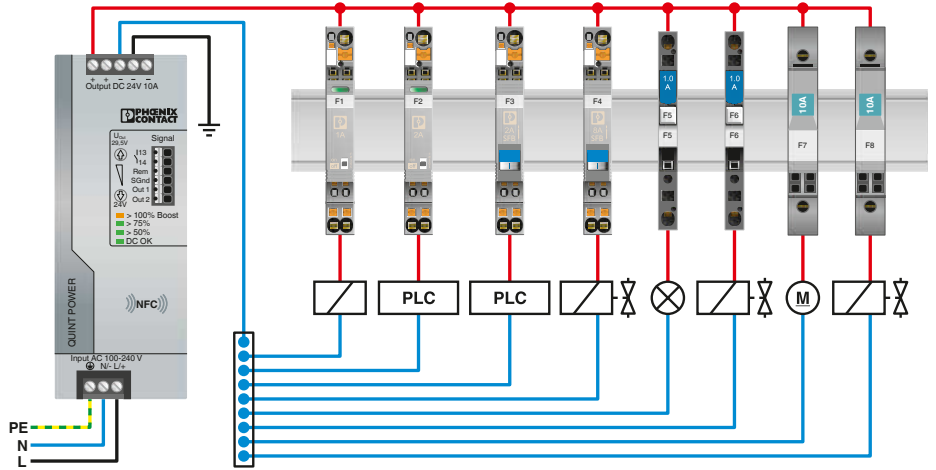

## Potential errors

### Overload currents

Overload currents occur when end devices unexpectedly require a higher current than the intended rated current. Such situations will arise, for example, when a drive is blocked. Temporary starting currents from machines are also considered to be overload currents. Although in principle their occurrence can be calculated, it can vary depending upon the machine load when starting. Take these conditions into account when selecting suitable fuses or circuit breakers for such circuits. Safe shutdown should occur within a range of a few seconds up to a few minutes.

### Short-circuit currents

Short circuits can occur between damaged conductors that are carrying operating voltage. Typical protective devices for shutting down short-circuit currents include fuses and miniature circuit breakers with various tripping mechanisms. Short-circuit currents should be reliably shut down in the milliseconds range.

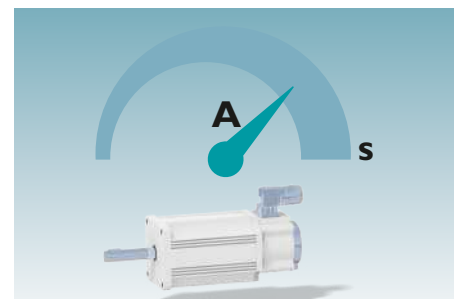
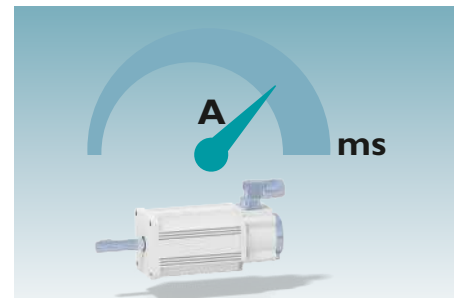

## Various technologies that provide different forms of protection

Phoenix Contact provides thermal, thermal-magnetic and electronic circuit breakers. The differences are in the tripping technology and the shutdown behavior. Characteristic curves are used to clearly illustrate the shutdown characteristics of the various device circuit breakers.

Thermal circuit breakers protect via a bimetallic strip that leads to tripping when heated. However, this takes between 300 ms and several minutes. In the event of overloads, this period of time is more than sufficient. The magnetic part of the thermal-magnetic circuit breaker provides

protection in the event of a short circuit. If the current suddenly increases, shutdown occurs within a few milliseconds. Electronic circuit breakers reliably protect against both overloads and short-circuit currents, and also offer many advantages. Current and voltage are measured and monitored permanently. Errors are detected far more precisely and quickly. Currents are assessed and shut down sooner or later, depending on their intensity. An electronic circuit breaker will trip at a significantly lower current than an electromechanical circuit breaker. This allows the power supply output to be utilized far more

efficiently. Lower reserves can therefore be dimensioned.

Device circuit breakers are selected based on the nominal voltage, nominal current, and, if required, the starting current of an end device. The expected error situation - short circuit or overload - then determines the appropriate shutdown behavior.

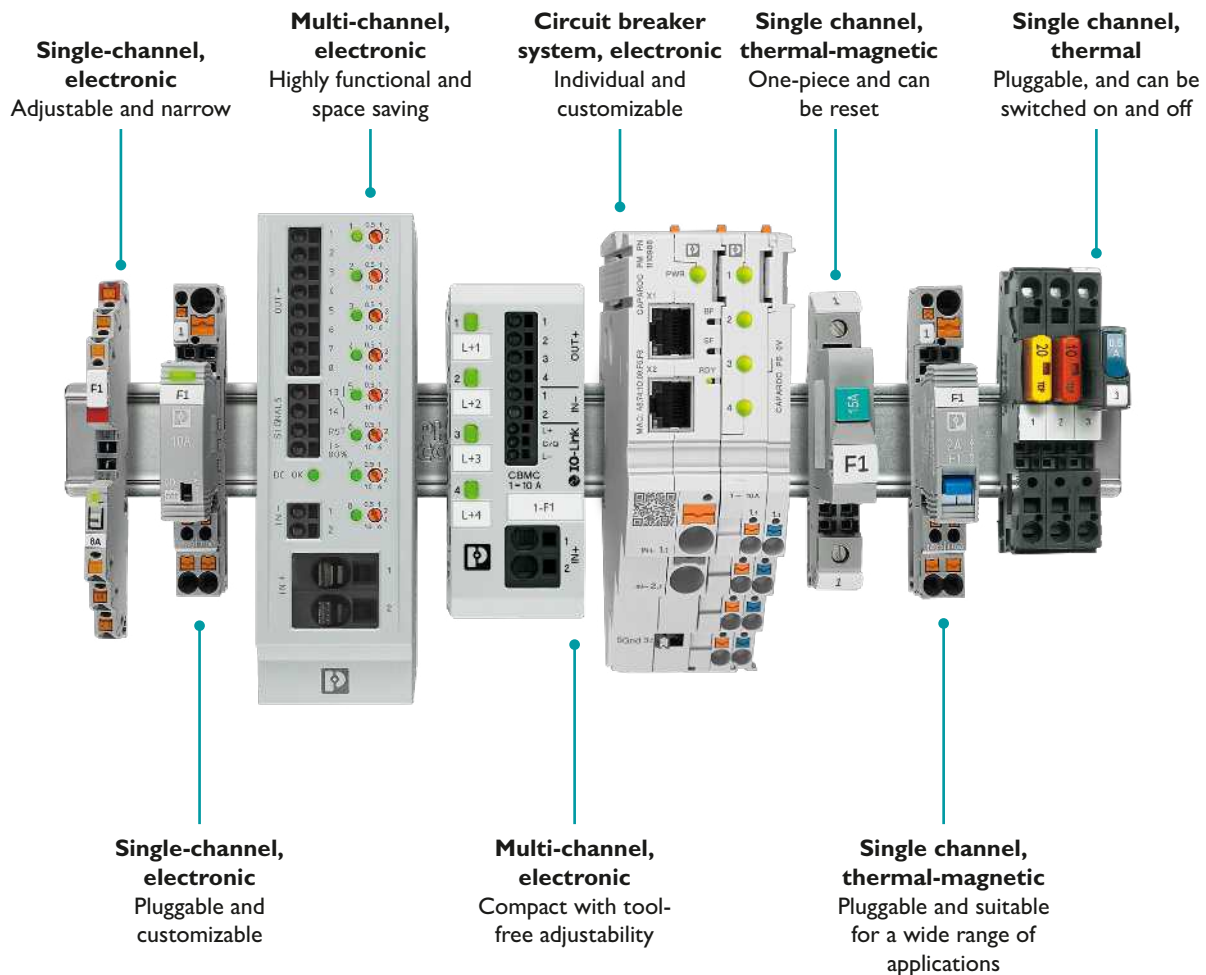

# Comparison of product features

Product family	CAPAROC	PTCB	CB E
<b>Customized order</b>			
Can be ordered preconfigured	•		
Complete system can be ordered	•		
<b>Installation and commissioning</b>			
Overall width per channel	6 mm <sup>*1</sup> (1-/2-channel)	6 mm	12 mm
Number of channels	1 / 2 / 4	1	1
Input voltage	12 V DC / 24 V DC	24 V DC	24 V DC
Nominal current range	1 A ... 10 A	1 A ... 8 A	1 A ... 10 A
Two-pole shutdown (isolated systems)			
Assisted nominal current setting	•		
Adjustable	•	•	
Parameterization lock	•		
Tool-free configuration	•	•	
Rotary switch configuration	•		
Protection against setting changes	Electronic	Electronic	•
Interchangeable with pluggability	•		•
Vertical wiring			•
Bridgeable to terminal blocks		•	
Electrical isolation			
<b>Additional functions</b>			
Current limitation	•		•
Remote signaling	•	•	•
Remote signaling early warning threshold	•		
Remote reset	•	•	•
Remotely controllable	• <sup>*3</sup>		•
Undervoltage/overvoltage switch-off	<10 V / >30 V	<18 V / >30 V	< 14 V / >30 V
High starting currents			
Breaking capacity at 24 V DC	300 A	300 A	- / -
<b>Communication</b>			
Communication (interface)	PROFINET / IO-Link		

<sup>\*1</sup> plus power module <sup>\*2</sup> EG4 version <sup>\*3</sup> via communication interface

CBM	CBMC	CB TM	UT 6-TMC	TCP ... / DC	TCP
	•				
5 mm	9 mm	12 mm	12 mm	6 mm	8.2 mm / 9.5 mm
4 / 8	4	1	1	1	1
24 V DC	24 V DC	24 V AC ... 277 V AC 5 V DC ... 72 V DC	50 V AC ... 264 V AC 5 V DC ... 30 V DC	32 V DC	250 V AC 65 V DC 72 V DC
0.5 A ... 10 A	1 A ... 10 A	0.5 A ... 16 A	0.5 A ... 16 A	5 A ... 40 A	0.5 A ... 20 A
		•			
•					
•	•				
	• *3				
	•				
•					
Electronic	Electronic	•	•	•	•
		•		•	•
		•		•	•
	• *2	•	•	•	•
•					
•	•	•			
•	• *3				
•	•				
	• *3				
<18 V / >30 V	<18 V / >30 V	- / -	- / -	- / -	- / -
		•	•	•	•
300 A	300 A	1500 A	400 A	2000 A	2000 A
	IO-Link				









### Multi-channel device circuit breakers

Multi-channel electronic circuit breakers can be adjusted individually for each channel and provide a functional, space-saving solution for every application.

More information starting on page 28

# Electronic circuit breakers: Intelligent, individual, and intuitive

## The advantages of electronic circuit breakers

Intelligent software is the core of an electronic circuit breaker. The software differentiates between operating currents and harmful currents and rapidly transmits commands to the electronic system. This is because it has to ensure that faults are detected and shut down as quickly as possible while not shutting off an inrush current or normal operating current. The switching operation is performed via the power transistor.

### Steps to error detection:

- **Measurement:** To monitor the ongoing situation, all electrical variables are measured continuously.
- **Analysis:** The measured values are analyzed in order to determine a course of action.

- **Classification:** The currents are evaluated and classified.
- **Protect and switch:** Depending on the class of the analyzed current, the load is started or shut down. The rest of the system thus remains in operation and unaffected.
- **Signaling:** The operating states of all circuits are transmitted continuously to the system operator. If an event occurs, it is detected immediately and reported.



## Overcurrents under control

Electronic circuit breakers are in some cases equipped with active current limitation. This function limits short circuit and overload currents. It protects the power supply against currents that are too high and prevents the output voltage from dropping at the switched-mode power supply unit.

### Current limitation

The extent of current limitation is described by a factor, normally between 1.25 and 2.0. This value is not exceeded, even in the event of an error. For the power supply, even a hard short circuit therefore has the same effect as a slight overload, the current is significantly lower than without current limitation and the supply voltage to the system remains unaffected.

### Without current limitation

With a circuit breaker without current limitation, the supply voltage can drop out in the event of an error, which means that all the connected devices would fail as well. In other words, in the event of an error, the installed electronics and the integrated firmware must react quickly and intelligently. Although a short circuit must be detected and shut down quickly, it must still be possible to reliably start a capacitive load.



## Setting the device circuit breaker correctly

To be able to determine the correct nominal current value for a device circuit breaker, you should know the load(s). However, the actual current often deviates from the manufacturer's information. In a load group, these errors accumulate, which means that the total current deviates even more from the calculated value.

Here, adjustable device circuit breakers offer a considerable advantage and remain flexible. Firstly, the set value should not be much higher than the flowing current value. The required starting current of a load can, however, influence the necessary set value. In this case, set the lowest value at which smooth operation can be assured.

### Adjustable circuit breakers

The intelligent software in electronic circuit breakers allows the nominal current to be set individually. This means you can maintain a high level of flexibility throughout. It is not always possible to determine the correct current value right at the start of a project. Adjustability is therefore a useful function, because the final current value can be determined during commissioning. You can provide optimal protection for every load, tailored precisely to the application.

This adjustability also provides you with the option of covering several applications with one device. This not only saves you inventory costs, it also makes selecting the correct circuit breaker much easier.

### Circuit breakers with fixed values

For many, circuit breakers provide a high degree of safety if the current value is not adjustable. In this case, nothing can be adjusted in the system, and all of the settings carried out by the installer remain unchanged. The current values must, however, be determined during configuration. If a value is unsuitable, the entire circuit breaker or protective plug must be replaced.

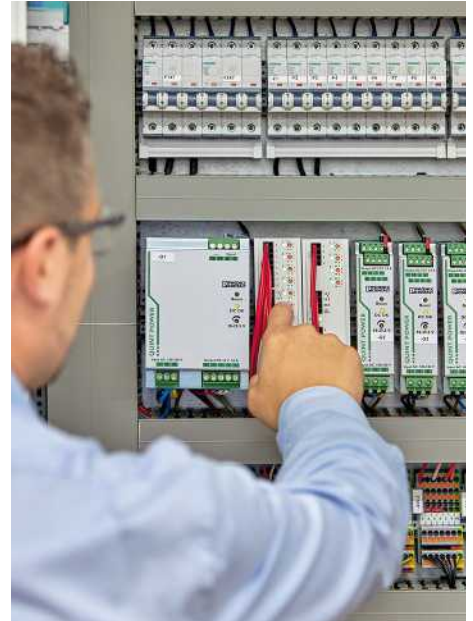

## Influence of cable lengths

Line resistance can limit the flowing current, which means that in the event of a short-circuit, the required tripping current does not flow and shutdown occurs too late.

Electronic circuit breakers require a much

lower tripping current, so only the voltage drop across the line needs to be considered, because if the voltage at the load is too low, the load supply is disrupted.

The following applies to electronic circuit breakers: If the load functions in rated operation, the circuit breaker will also trip reliably in the event of a fault.

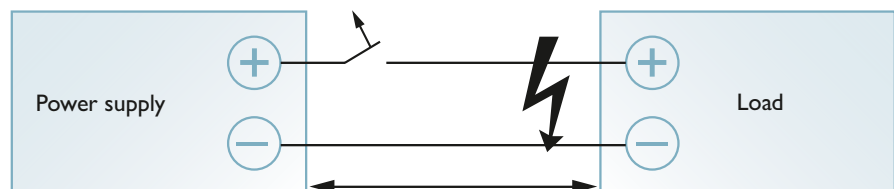

## Electronic circuit breakers

# Circuit breaker system

CAPAROC is your individual modular system for overcurrent protection. With many combination options, easy operation, and rapid design-in, you receive your own personal benchmark in device protection. Using this system, you are perfectly positioned for the future.

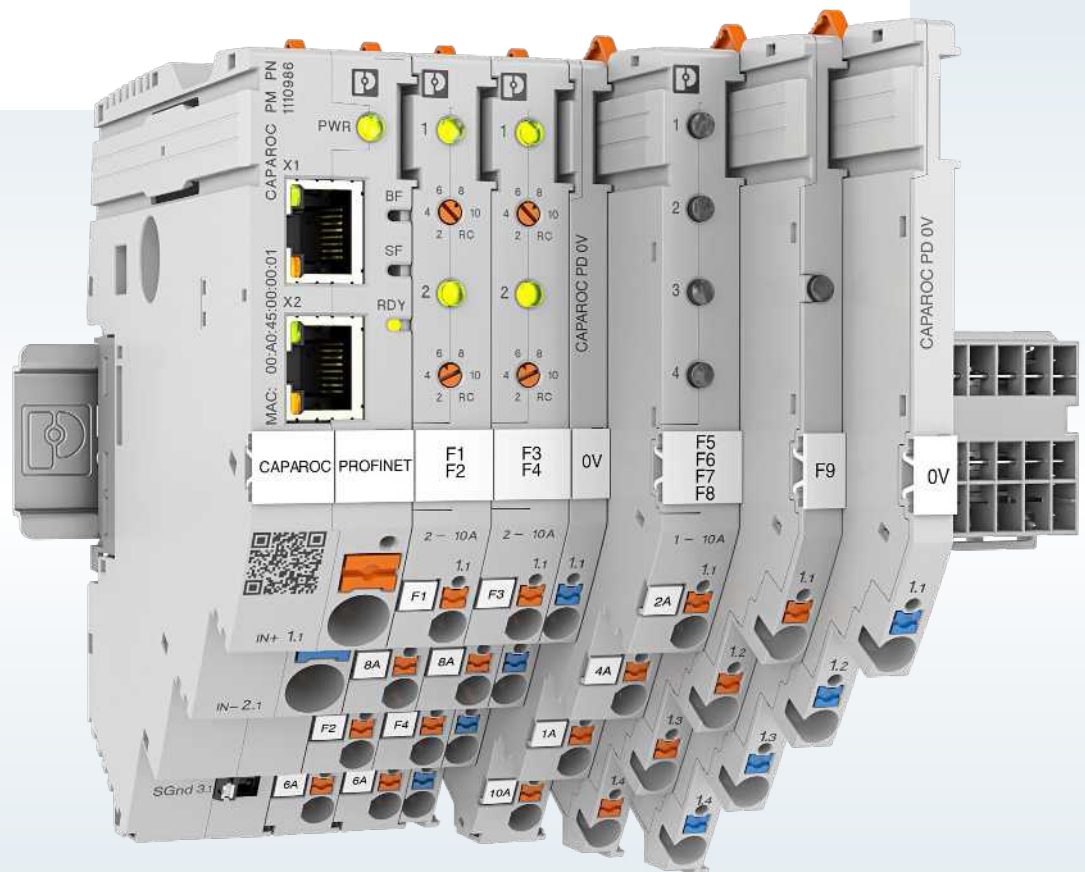

### Your advantages

- ✓ The customizable standard with a wide range of possible combinations
- ✓ Easy operation for all with tool-free assembly, installation without interruptions
- ✓ Strikingly simple design-in with extensive support from selection to digital services

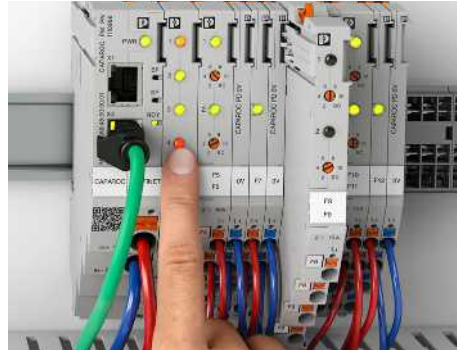
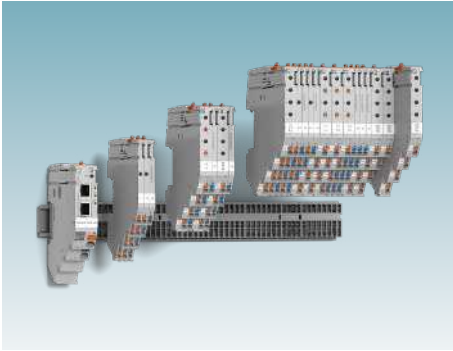

## Customizable standard

The system for the future: Thanks to a wide range of individual modules and many combination options you create your customized solution with CAPAROC. The modular system is completely compatible, always technologically up-to-date with future updates, and extendable at any time – even during operation.

## Easy operation

Use CAPAROC and experience easy operation through tool-free assembly, uninterrupted installation, and a transparent operating state. The modules can easily be snapped on, even when assembled. The easy nominal current setting and the clear identification of connections and potentials ensure intuitive operation.

## Intuitive design-in

Strikingly simple: The online configurator helps you assemble a system that precisely meets your needs, and with your personal item number you can reorder your solution again and again. Appropriate digital services support you, for example, with your individual data from the 3D model and marking to the data sheet.

## Product overview

**Power modules**  
Supply and communicate centrally



**4-channel circuit breaker modules**  
4-channel protection on just 12.4 mm

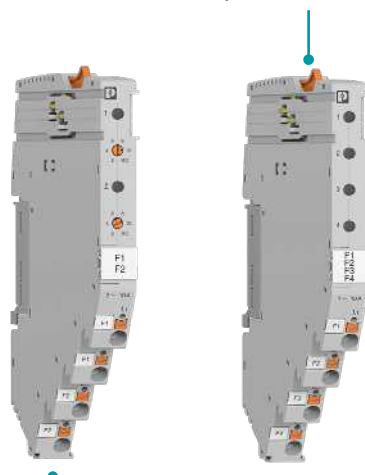

**Potential distributors**  
For load supply of plus and 0 V



**2-channel circuit breaker modules**  
Intuitive and easy configuration

**1-channel circuit breaker modules**  
4 protected outputs on 6.2 mm

# Circuit breaker system

## Supply and communicate centrally

The system design starts with the power module. Central feed-in and communication are managed here. All additional modules are supplied directly via the rear-side current rail. With automatic module addressing in the system, no further effort is needed. All system information is collected via the power module and forwarded to the provided interface for evaluation. This ensures that you have transparency across the entire 24 V supply network.

### Communication

The power module is the nerve center of the system. All data and signals are collected here and issued via the status output. The output  $I > 80\%$  issues a signal if the load on a channel

reaches at least 80% capacity. You can respond before a failure occurs. You can switch the channels that have been disconnected back on remotely via the reset input.

All data can be queried via the integrated PROFINET interface. Configure the channels and keep an eye on the current flowing. You can read off past events from the error log. This reduces troubleshooting times considerably and you have a complete overview of the entire supply.

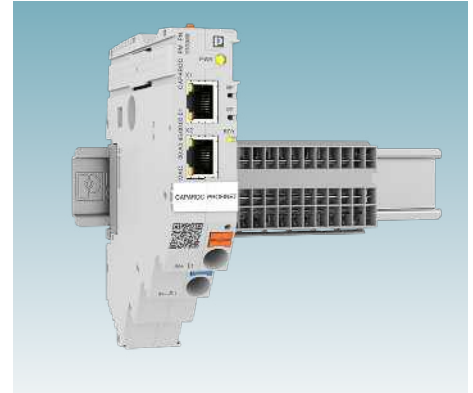

## Central feed-in

The rear-side current rails of the CAPAROC system are used to supply all modules reliably. By connecting the supply line for positive and negative to the power module, the current rails are also supplied directly. This both reduces the amount of installation work and also eliminates installation errors between the feed-in and the fused connections of each protective module. The current rails connect the power module to every single module in the system.

With potential distributors that can be integrated into the system, the return conductor from every fused circuit can be optimally connected in the system. The color-coded push buttons also integrated here make it easy to see what function the respective connections have. This helps to prevent wiring errors. Additional terminal blocks are not necessary.

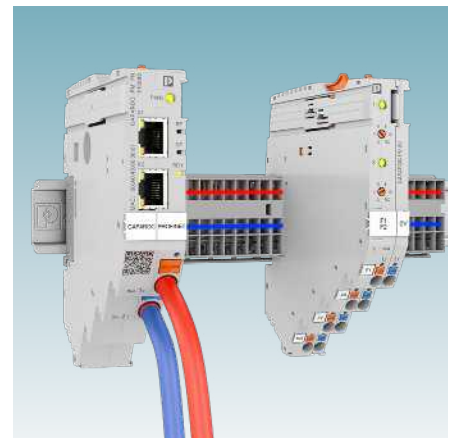



# Circuit breaker system

## QUINT POWER and CAPAROC – the communicative 24 V supply system

Combine the QUINT POWER IOL power supply with the CAPAROC circuit breaker system or the intelligent QUINT4 DC UPS (from rev. 05). This will supply and protect your system even more intelligently.

Our communicative 24 V supply system increases the data transparency of the entire system and provides information on all relevant operating and diagnostic data. One central interface for QUINT POWER and CAPAROC ensures simple and cost-efficient integration of the power supply into the network protocol of the circuit breaker system: The PROFINET interface enables complete transparency

and access to the entire system. A web server enables on-site access to operating states, error messages, and setting details of the system solution. The supply solution offers complete data consistency, from the primary side to the secured device circuits. Preventative function monitoring also helps you reduce downtimes to a minimum.

### General operating data

- Temperature
- Operational runtime
- Remaining service life

### Digital nameplate

- Device IDs
- Item numbers
- Serial numbers
- Revisions
- Production data

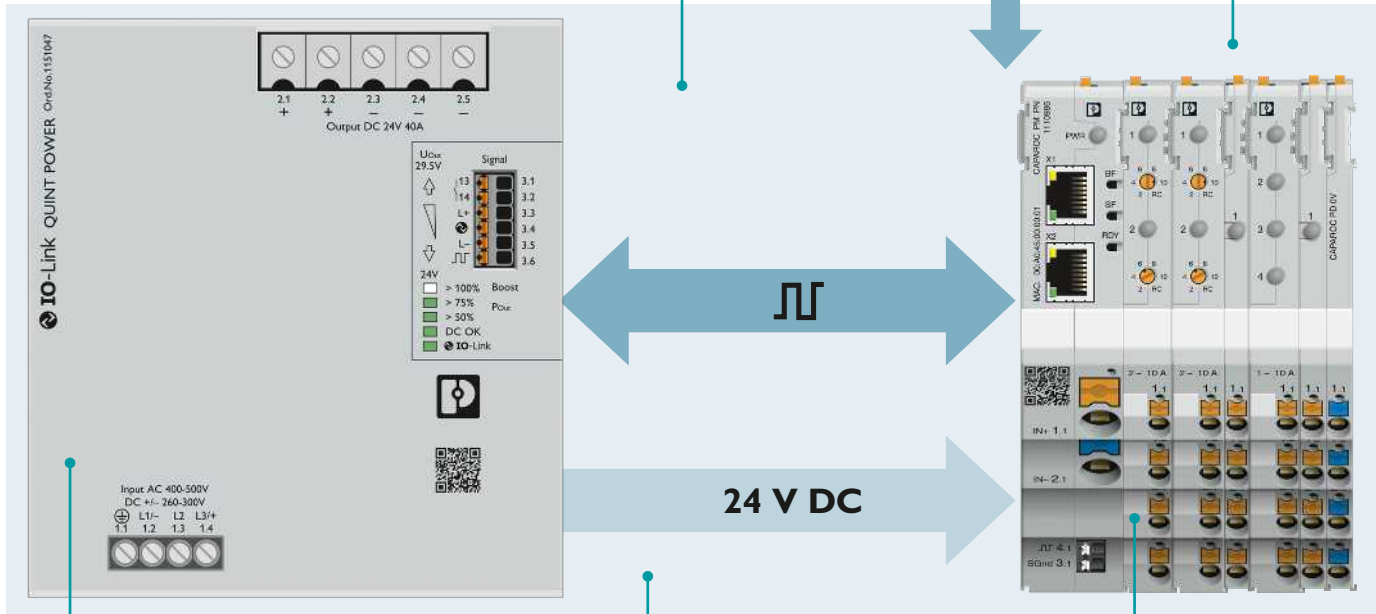

### AC-side diagnostic data

- 3 AC input voltage
- Phase monitoring
- Input frequency
- Rotary field direction

### DC-side diagnostic data





- Current
- Voltage
- DC OK
- P < PN







### Diagnostic data for the fused DC-side

- Status of all circuits
- On, off, error message
- Early warning at channel current load >80%
- Flowing current
- Error memory



# CAPAROC circuit breaker system

Power modules			
			
Communication	Status output and reset input	IO-Link <span style="background-color: #e91e63; color: white; padding: 2px;">new</span>	PROFINET <span style="background-color: #e91e63; color: white; padding: 2px;">new</span>
Approvals			
Operating voltage	12 V DC / 24 V DC		
Rated current	45 A DC		
Number of slots	2		4
Connection cross-section	Main circuit IN+: 0.5 mm <sup>2</sup> ... 16 mm <sup>2</sup> Main circuit IN-: 0.5 mm <sup>2</sup> ... 16 mm <sup>2</sup>	Main circuit IN+: 0.5 mm <sup>2</sup> ... 16 mm <sup>2</sup> Main circuit IN-: 0.5 mm <sup>2</sup> ... 16 mm <sup>2</sup>	Main circuit IN+: 0.5 mm <sup>2</sup> ... 16 mm <sup>2</sup> Main circuit IN-: 0.5 mm <sup>2</sup> ... 16 mm <sup>2</sup>
W x H x D in mm	12.4 x 132.4 x 111.3		24.8 x 132.4 x 111.3
Type	CAPAROC PM S-R	CAPAROC PM IOL	CAPAROC PM PN
Item no.	<a href="#">1115661</a>	<a href="#">1115670</a>	<a href="#">1110986</a>

Circuit breaker modules, fixed value						
						
Rated current	<b>1 A</b>	<b>2 A</b>	<b>4 A</b>	<b>6 A</b>	<b>8 A</b>	<b>10 A</b>
Approvals						
Number of channels	1-channel					
Operating voltage	12 V DC / 24 V DC					
Backup fuse	5 A DC			15 A DC		
Number of slots	1					
Connection cross-section	Fuse-protected output: 0.25 mm <sup>2</sup> ... 4 mm <sup>2</sup>					
W x H x D in mm	6.2 x 132.4 x 111.3					
Type	CAPAROC E1 12-24DC/ 1A	CAPAROC E1 12-24DC/ 2A	CAPAROC E1 12-24DC/ 4A	CAPAROC E1 12-24DC/ 6A	CAPAROC E1 12-24DC/ 8A	CAPAROC E1 12-24DC/ 10A
Item no.	<a href="#">1157288</a>	<a href="#">1157290</a>	<a href="#">1157285</a>	<a href="#">1157286</a>	<a href="#">1157279</a>	<a href="#">1157284</a>







# CAPAROC circuit breaker system



1

2







3

Electronic circuit breakers

Circuit breaker modules, adjustable						
						
Rated current	1 / 2 / 3 / 4 A DC	1 / 2 / 3 / 4 / 5 / 6 / 7 / 8 / 9 / 10 A DC	1 / 2 / 3 / 4 A DC	2 / 4 / 6 / 8 / 10 A DC	1 / 2 / 3 / 4 A DC	1 / 2 / 3 / 4 / 5 / 6 / 7 / 8 / 9 / 10 A DC
Approvals						
Number of channels	1-channel		2-channel		4-channel	
Operating voltage	12 V DC / 24 V DC					
Backup fuse	5 A DC	15 A DC	5 A DC	15 A DC	5 A DC	15 A DC
Number of slots	1		2			
Connection cross-section	Fuse-protected output: 0.25 mm <sup>2</sup> ... 4 mm <sup>2</sup>					
W x H x D in mm	6.2 x 132.4 x 111.3		12.4 x 132.4 x 111.3			
Type	CAPAROC E1 12-24DC/ 1-4A	CAPAROC E1 12-24DC/ 1-10A	CAPAROC E2 12- 24DC/ 1-4A	CAPAROC E2 12- 24DC/ 2-10A	CAPAROC E4 12- 24DC/ 1-4A	CAPAROC E4 12- 24DC/ 1-10A
Item no.	1115415	1115649	1115655	1110984	1115657	1115658

Potential distribution module - 0 V	
	
Rated current	Four outputs, each 10 A DC
Approvals	
Operating voltage	12 V DC / 24 V DC
Connection cross-section	Load circuit: 0.25 mm <sup>2</sup> ... 4 mm <sup>2</sup>
W x H x D in mm	6.2 x 132.4 x 109.9
Type	CAPAROC PD 0V
Item no.	1110987

# CAPAROC circuit breaker system

Current rails				
	Initial current rails			
				
Length in mm	123.8	49.4		
Approvals				
Number of slots	20	8		
Rated current	45 A DC			
Type	CAPAROC CR 20	CAPAROC CR 8		
Item no.	1110989	1115672		
	Extension current rails			
				
Length in mm	133.6	59.2	34.4	
Approvals				
Number of slots	20	8	4	
Rated current	45 A DC			
Type	CAPAROC CR EXT20	CAPAROC CR EXT8	CAPAROC CR EXT4	
Item no.	1115674	1110990	1110991	

Current rails, optional accessories	
	Connectors
	
Type	CAPAROC CR CON
Item no.	1270955

## QUINT POWER with IO-Link

The new communicative QUINT POWER power supply with IO-Link can be integrated into industrial networks quickly and easily.

With the integrated IO-Link interface, all the relevant operating data of the power supply, from the 3-AC side to the 24 V DC side, can be made available to the higher-level automation system. Calculating the usage-dependent service life enables





predictive maintenance, lifting preventative function monitoring to an entirely new level.





The power supply also enables configuration via IO-Link. The configuration is adopted directly after a device is replaced, saving time and avoiding user errors.

SFB Technology 

Designed by Phoenix Contact



QUINT POWER, 3~		SFB Technology  Designed by Phoenix Contact	
	 	 	
Input	3x 320 V AC ... 550 V AC 2x 360 V AC ... 550 V AC ± 226 V DC ... 390 V DC	3x 320 V AC ... 550 V AC 2x 360 V AC ... 550 V AC ± 226 V DC ... 390 V DC	
W x H x D in mm	70 x 130 x 125	120 x 130 x 125	
	<b>24 V / 20 A</b> <span style="background-color: #e91e63; color: white; padding: 2px;">new</span>	<b>24 V / 40 A</b> <span style="background-color: #e91e63; color: white; padding: 2px;">new</span>	
Type	QUINT4-PS/3AC/24DC/20/IOL	QUINT4-PS/3AC/24DC/40/IOL	
Item no.	1151048	1151047	

QUINT POWER, 1~				SFB Technology  Designed by Phoenix Contact	
					
Input	85 V AC ... 264 V AC 90 V DC ... 350 V DC	85 V AC ... 264 V AC 90 V DC ... 350 V DC	85 V AC ... 264 V AC 90 V DC ... 350 V DC	85 V AC ... 264 V AC 90 V DC ... 350 V DC	
W x H x D in mm	36 x 130 x 125	50 x 130 x 125	70 x 130 x 125	120 x 130 x 140	
	<b>24 V / 5 A</b>	<b>24 V / 10 A</b>	<b>24 V / 20 A</b>	<b>24 V / 40 A</b>	
Type	QUINT4-PS/1AC/24DC/5	QUINT4-PS/1AC/24DC/10	QUINT4-PS/1AC/24DC/20	QUINT4-PS/1AC/24DC/40	
Item no.	2904600	2904601	2904602	2904603	
		<b>12 V / 15 A</b>			
Type		QUINT4-PS/1AC/12DC/15			
Item no.		2904608			
		<b>48 V / 5 A</b>	<b>48 V / 10 A</b>	<b>48 V / 20 A</b> <span style="background-color: #e91e63; color: white; padding: 2px;">new</span>	
Type		QUINT4-PS/1AC/48DC/5	QUINT4-PS/1AC/48DC/10	QUINT4-PS/1AC/48DC/20	
Item no.		2904610	2904611	2904612	

## Electronic circuit breakers

# Single-channel circuit breakers – adjustable and narrow

The narrow and universal circuit breakers are perfectly suited for simple, space-saving potential distribution. The single-channel electronic circuit breaker can be bridged to the CLIPLINE complete terminal block system, and offers a setting range from 1 to 8 A with a narrow overall width.

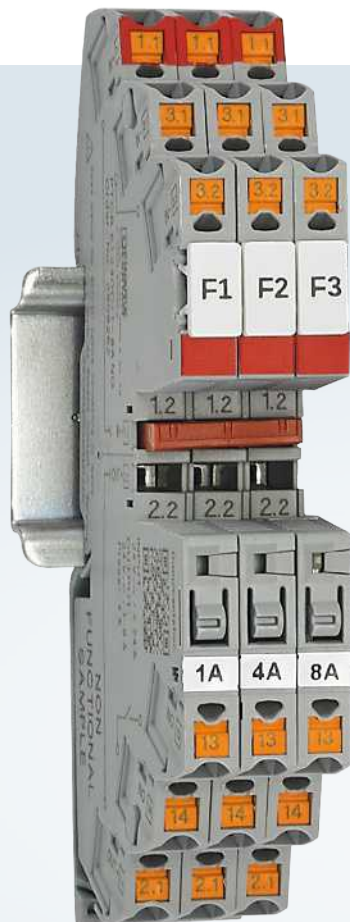

### Your advantages

- ✓ Simple application setup with the ability to bridge to the CLIPLINE complete terminal block range
- ✓ More space in the control cabinet: narrow protection with a width of just 6 mm
- ✓ Flexible use and less inventory due to adjustable current values on each device for a wide range of applications

## Space-saving and flexible setup of applications

The PTCB device circuit breaker can be bridged to the CLIPLINE complete terminal block system. You can use standard terminal blocks and accessories from the CLIPLINE complete system, and do not have to qualify any new materials. This enables you to quickly and easily add the ideal protection module to your existing applications.

### More space in the control cabinet

The PTCB enables potential distribution and device protection to be combined in a fast, space-saving manner. With an overall width of just 6 mm, the PTCB reliably protects against overload and short-circuit currents. This enables you to achieve space savings of

up to 70% compared to standard miniature circuit breakers. You benefit from reliable protection that takes up very little space.

### Flexible in use

With adjustable current values from 1 to 8 A, you can cover a wide range of applications. You can make modifications during commissioning. You can respond to changes in the application at any time. Further, you can reduce inventory and logistic costs with the flexible PTCB device circuit breaker for a wide range of applications.

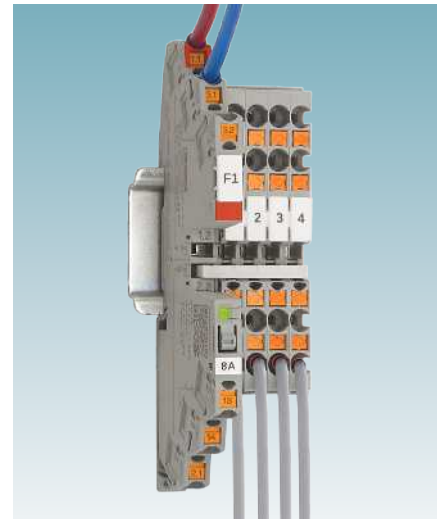

## Individual setup

Anything is possible: the individually configurable device circuit breaker offers unlimited possibilities. The number of channels you want to protect is irrelevant. Eliminate unnecessary channels, thereby reducing the costs of your system – with the flexible PTCB device circuit breaker for a wide variety of applications.

### Transparent operating state

The LED indicates the operating state of the product and the connected devices. The status is visualized via traffic light colors. This unambiguous display allows you to intuitively understand the operating state and provides a quick overview. With the remote messaging function, you have the option of transmitting the status to a remote maintenance station.

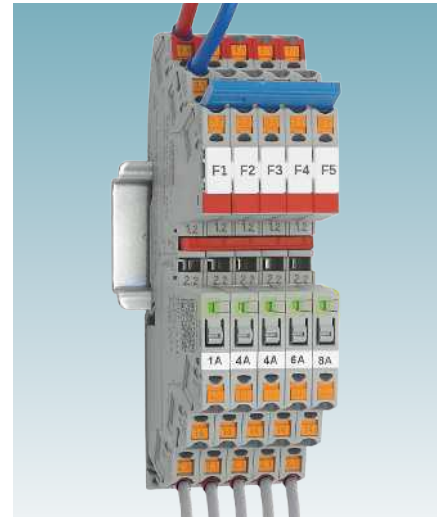



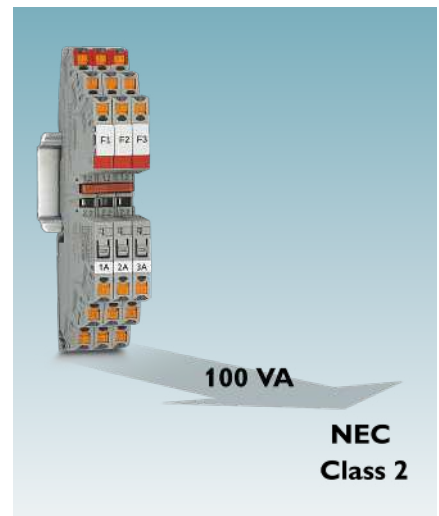

## NEC Class 2 circuits

The device circuit breakers are also approved in accordance with NEC Class 2. You can therefore easily configure energy-limited circuits with PTCB. Instead of an NEC Class 2 power supply unit, simply use your powerful standard power supply unit. Benefit from quicker and easier installation and testing of your application.











# Single channel circuit breakers

Adjustable and narrow						
PTCB – with floating contact 13-14, adjustable						
						
<b>Rated current</b>	<b>1 / 2 / 3 A DC</b>		<b>1 / 2 / 3 / 4 A DC</b>		<b>1 / 2 / 3 / 4 / 5 / 6 / 7 / 8 A DC</b>	
Approvals						
Number of positions	1-pos.					
Operating voltage	24 V DC					
Backup fuse	4 A DC				15 A DC	
Connection cross-section	Main circuit IN+: 0.2 mm <sup>2</sup> ... 2.5 mm <sup>2</sup> Main circuit IN-: 0.2 mm <sup>2</sup> ... 2.5 mm <sup>2</sup> Main circuit OUT: 0.2 mm <sup>2</sup> ... 2.5 mm <sup>2</sup>					
W x H x D in mm	6.2 x 105.8 x 55.6					
Type	PTCB E1 24DC/ 1-3A NO		PTCB E1 24DC/ 1-4A NO		PTCB E1 24DC/ 1-8A NO	
Item no.	2909909		2908261		2908262	
PTCB – with floating contact 13-14, fixed rated currents						
						
<b>Rated current</b>	<b>1 A</b>	<b>2 A</b>	<b>3 A</b>	<b>4 A</b>	<b>6 A</b>	<b>8 A</b>
Approvals						
Number of positions	1-pos.					
Operating voltage	24 V DC					
Backup fuse	4 A DC				15 A DC	
Connection cross-section	Main circuit IN+: 0.2 mm <sup>2</sup> ... 2.5 mm <sup>2</sup> Main circuit IN-: 0.2 mm <sup>2</sup> ... 2.5 mm <sup>2</sup> Main circuit OUT: 0.2 mm <sup>2</sup> ... 2.5 mm <sup>2</sup>					
W x H x D in mm	6.2 x 105.8 x 55.6					
Type	PTCB E1 24DC/ 1A NO	PTCB E1 24DC/ 2A NO	PTCB E1 24DC/ 3A NO	PTCB E1 24DC/ 4A NO	PTCB E1 24DC/ 6A NO	PTCB E1 24DC/ 8A NO
Item no.	2909902	2909903	2909904	2909906	2909908	2909910



# Single channel circuit breakers

Adjustable and narrow					
<b>PTCB – with status output and reset input, adjustable</b>					
					
<b>Rated current</b>	<b>1 / 2 / 3 / 4 A DC</b>			<b>1 / 2 / 3 / 4 / 5 / 6 / 7 / 8 A DC</b>	
Approvals	  				
Number of positions	1-pos.				
Operating voltage	24 V DC				
Backup fuse	5 A DC			15 A DC	
Connection cross-section	Main circuit IN+: 0.2 mm <sup>2</sup> ... 2.5 mm <sup>2</sup> Main circuit IN-: 0.2 mm <sup>2</sup> ... 2.5 mm <sup>2</sup> Main circuit OUT: 0.2 mm <sup>2</sup> ... 2.5 mm <sup>2</sup>				
W x H x D in mm	6.2 x 105.8 x 55.6				
Type	PTCB E1 24DC/ 1-4A SI-R			PTCB E1 24DC/ 1-8A SI-R	
Item no.	1135753			1135752	
<b>PTCB – with status output and reset input, fixed nominal currents</b>					
					
<b>Rated current</b>	<b>1 A</b>	<b>2 A</b>	<b>4 A</b>	<b>6 A</b>	<b>8 A</b>
Approvals	  				
Number of positions	1-pos.				
Operating voltage	24 V DC				
Backup fuse	5 A DC			15 A DC	
Connection cross-section	Main circuit IN+: 0.2 mm <sup>2</sup> ... 2.5 mm <sup>2</sup> Main circuit IN-: 0.2 mm <sup>2</sup> ... 2.5 mm <sup>2</sup> Main circuit OUT: 0.2 mm <sup>2</sup> ... 2.5 mm <sup>2</sup>				
W x H x D in mm	6.2 x 105.8 x 55.6				
Type	PTCB E1 24DC/ 1A SI-R	PTCB E1 24DC/ 2A SI-R	PTCB E1 24DC/ 4A SI-R	PTCB E1 24DC/ 6A SI-R	PTCB E1 24DC/ 8A SI-R
Item no.	1135751	1135749	1135745	1135740	1135734

## Electronic circuit breakers

# Single-channel circuit breakers – pluggable and customizable

Build custom applications according to your requirements. The number of loads you need to protect is irrelevant. Single-channel device circuit breakers can be expanded in a modular fashion and adapted to the particular situation.



### Your advantages

- ✓ Simple application setup with the ability to bridge to the CLIPLINE complete terminal block range
- ✓ Flexible use with adjustable current values on each device for a wide range of applications
- ✓ Active current limitation to improve the capacity of the upstream power supply

## Customizable

Pre-wire systems and control cabinets with base elements. Simply install the appropriate protective plug to suit your individual requirements at a later date. If the demands placed on the load change in the meantime, you can simply replace the protective plug. The secure latching ensures the plug remains firmly in place, even in harsh environments.

### Protection against changes

Increase the security of your system through fixed current values. This prevents unintentional adjustment of the channel currents. A large selection of protective plugs is available with CB E circuit breakers. The nominal currents range from 1 to 10 A. Select the right protective plug for your area of application.

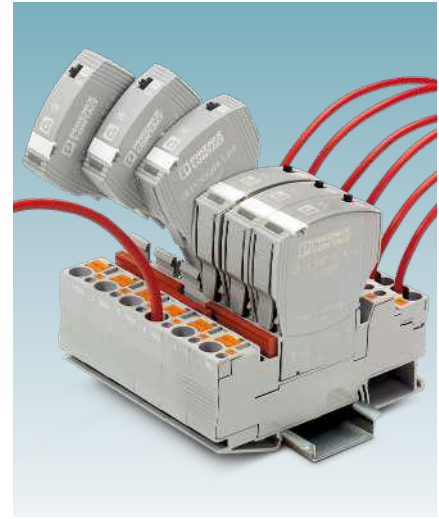

## Remote control

The control function of our CB E series does more than just provide you with the ability to switch different loads on and off remotely.

It is also possible to reset a channel that has tripped. This eliminates the need for on-site maintenance if no ongoing fault has occurred.

### Remote inspection

Increase the transparency of your system via our integrated remote messaging function. In the event of an error, you can obtain an overview of the problem – regardless of your location. This lets you find the faulty channel more quickly and therefore reduces the corresponding downtimes.



## Quick and easy installation



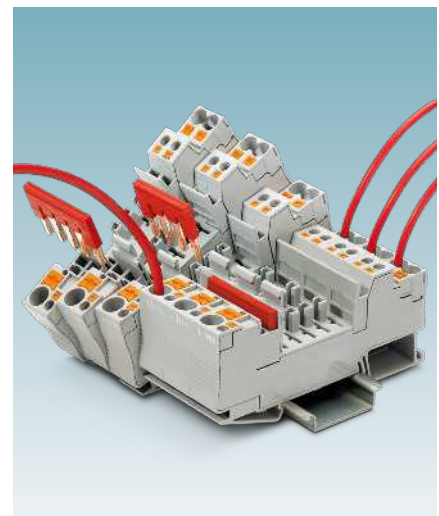

The device circuit breakers can be easily combined using the unique bridging system from our standard range. Potentials of the same type can be connected quickly and safely. Push-in connection technology enables you to wire the devices tool-free. This saves time and costs during installation.

### Active current limitation

Active current limitation restricts short circuit and overload currents to a value of 1.25 times the nominal current. This protects the power supply against excessively high currents and prevents output voltage dips at the switched-mode power supply unit. In addition, longer cable paths between the power supply and load are possible without negatively impacting shutdown behavior.



# Single channel circuit breakers

Pluggable and customizable							
CB E – modular, with N/O contact (normally open)							
							
<b>Nominal current</b>	<b>1 A</b>	<b>2 A</b>	<b>3 A</b>	<b>4 A</b>	<b>6 A</b>	<b>8 A</b>	<b>10 A</b>
Approvals							
Number of positions	1-pos.						
Operating voltage	24 V DC						
Backup fuse	2 A DC	4 A DC	6.3 A DC	6 A DC	10 A DC	15 A DC	
W x H x D in mm	12.3 x 45 x 52						
Type	CB E1 24DC/ 1A NO P	CB E1 24DC/ 2A NO P	CB E1 24DC/ 3A NO P	CB E1 24DC/ 4A NO P	CB E1 24DC/ 6A NO P	CB E1 24DC/ 8A NO P	CB E1 24DC/ 10A NO P
Item no.	2800901	2800902	2800903	2800904	2800905	2800906	2800907
CB E – modular, with N/C contact (normally closed)							
							
<b>Nominal current</b>	<b>1 A</b>	<b>2 A</b>	<b>3 A</b>	<b>4 A</b>	<b>6 A</b>		
Approvals							
Number of positions	1-pos.						
Operating voltage	24 V DC						
Backup fuse	2 A DC	4 A DC	6 A DC	6.3 A DC	10 A DC		
W x H x D in mm	12.3 x 45 x 52						
Type	CB E1 24DC/ 1A NC P	CB E1 24DC/ 2A NC P	CB E1 24DC/ 3A NC P	CB E1 24DC/ 4A NC P	CB E1 24DC/ 6A NC P		
Item no.	2800915	2800916	2800917	2800918	2800919		









# Single channel circuit breakers

1

2

3

Electronic circuit breakers

Pluggable and customizable							
CB E – modular, with status output and reset input (S-R)							
							
<b>Nominal current</b>	<b>1 A</b>	<b>2 A</b>	<b>3 A</b>	<b>4 A</b>	<b>6 A</b>	<b>8 A</b>	<b>10 A</b>
Approvals							
Number of positions	1-pos.						
Operating voltage	24 V DC						
Backup fuse	2 A DC	4 A DC	6 A DC	6.3 A DC	10 A DC	15 A DC	
W x H x D in mm	12.3 x 45 x 52						
Type	CB E1 24DC/ 1A S-R P	CB E1 24DC/ 2A S-R P	CB E1 24DC/ 3A S-R P	CB E1 24DC/ 4A S-R P	CB E1 24DC/ 6A S-R P	CB E1 24DC/ 8A S-R P	CB E1 24DC/ 10A S-R P
Item no.	2800908	2800909	2800910	2800911	2800912	2800913	2800914
CB E – modular, with status output and control input (S-C)							
							
<b>Nominal current</b>	<b>1 A</b>	<b>2 A</b>	<b>3 A</b>	<b>4 A</b>	<b>6 A</b>	<b>8 A</b>	<b>10 A</b>
Approvals							
Number of positions	1-pos.						
Operating voltage	24 V DC						
Backup fuse	2 A DC	4 A DC	6 A DC		10 A DC	15 A DC	
W x H x D in mm	12.3 x 45 x 52						
Type	CB E1 24DC/ 1A S-C P	CB E1 24DC/ 2A S-C P	CB E1 24DC/ 3A S-C P	CB E1 24DC/ 4A S-C P	CB E1 24DC/ 6A S-C P	CB E1 24DC/ 8A S-C P	CB E1 24DC/ 10A S-C P
Item no.	2800922	2800923	2800924	2800925	2800926	2800927	2800928
Necessary accessories for CB E							
	Base element						
							
<b>Connection technology</b>	<b>Push-in connection</b>		<b>Screw connection</b>		<b>Solder connection</b>		
Approvals							
Mounting type	DIN rail: 35 mm					On PCB	
Connection cross-section	Connection 1: 0.5 mm <sup>2</sup> ... 6 mm <sup>2</sup> Connection 2.1 / 2.2: 0.2 mm <sup>2</sup> ... 4 mm <sup>2</sup> Connection 12 / 11 / 14: 0.14 mm <sup>2</sup> ... 1.5 mm <sup>2</sup>		Connection 1: 0.5 mm <sup>2</sup> ... 10 mm <sup>2</sup> Connection 2: 0.5 mm <sup>2</sup> ... 10 mm <sup>2</sup> Connection 12 / 11 / 14: 0.14 mm <sup>2</sup> ... 2.5 mm <sup>2</sup>				
W x H x D in mm	12.3 x 90 x 46.7		12.3 x 90.8 x 70		12.3 x 34.8 x 36.4		
Type	CB 1/6-2/4 PT-BE		CB 1/10-1/10 UT-BE		CB S-BE		
Item no.	2800929		2801305		2905067		

## Electronic circuit breakers

# Multi-channel circuit breakers – compact with tool-free adjustability

CBMC circuit breakers are tailored exactly to your specific requirements. They combine a compact design with options for individual adjustment. This means that you can easily and flexibly adjust currents, save space, and reliably protect all applications with just one device. A version with the IO-Link interface makes it possible to integrate the device circuit breakers into the process monitoring and control systems.



### Your advantages

- ✓ Easy device replacement without re-planning, with a compact design and options for individual adjustment
- ✓ Circuits can be adjusted tool-free via a single LED pushbutton
- ✓ Worldwide access to the device with integration into your IO-Link infrastructure

## CBMC compact multi-channel electronic circuit breakers

Save space in the control cabinet with the CBMC, or convert existing systems with little effort. With the combination of compact overall width and individual adjustability, selecting the correct product is easy. At the same time you save inventory costs because only one device is required.

The integrated early warning system also ensures fewer failures with CBMC. When the set nominal current of a channel reaches 80%, a warning is output via the associated LED.

This means that you can easily and flexibly adjust currents, save space, and reliably protect all applications with just one device.

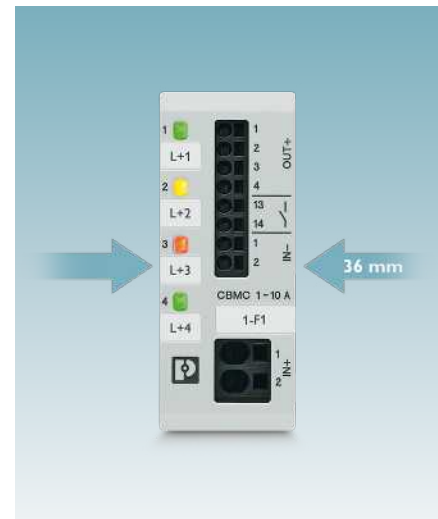

## Intelligent control and comprehensive monitoring with IO-Link

The CBMC portfolio also includes versions with the IO-Link interface. IO-Link lets you fully integrate the device circuit breakers into the process monitoring and control systems. It gives you a continuous overview of process-related data, keeping you up to date at all times and from anywhere.

Device circuit breaker versions equipped with status output and reset input give you more diagnostic and control options in your system. After all, this product provides the option of remotely resetting the circuit. It also makes it possible to install the device circuit breaker in locations that are difficult to access.

Another version electrically interrupts load outputs with the help of built-in relays. In this case, as opposed to other electronic circuit breakers, the protected output is not only switched to high impedance in the event of an error, but is also electrically isolated.



## NEC Class 2 circuits

The 1-4 A version is approved in accordance with NEC Class 2. You can therefore easily configure energy-limited circuits with the CBMC. Instead of an NEC Class 2 power supply unit, simply use your powerful standard power supply unit. Benefit from quicker and easier installation and testing of your application.

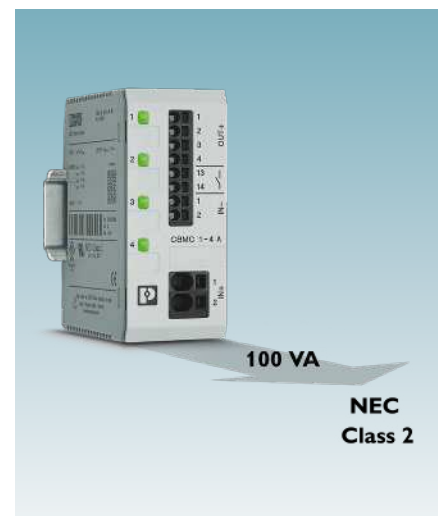



## Electronic circuit breakers

# Multi-channel circuit breakers – highly functional and space-saving

Four to eight channels can be safely protected against overload and short-circuit currents with CBM multi-channel device circuit breakers. Configuring a device circuit breaker has never been easier. Using the integrated nominal current assistant, selecting the appropriate current for the connected load is incredibly easy. This makes configuration fast, convenient, and simple.



### Your advantages

- ✓ Easy to configure with the nominal current assistant
- ✓ Active current limitation to improve the capacity of the upstream power supply
- ✓ Adjustable in increments per channel: from 0.5 A to 10 A

## CBM device circuit breakers with nominal current assistants

The nominal current assistant makes configuration of the CBM exceptionally easy. It enables load currents to be adjusted optimally. Simply turn the potentiometers, until the optimal current has been found. The LED indicates when the ideal setting has been found. Configuring system protection could not be easier.

Active current limitation restricts short circuit and overload currents to a value that is 1.5 to 2 times the nominal current. This protects the power supply against excessively high currents and prevents output voltage dips at the switched-mode power supply unit. In addition, longer cable paths between the power supply and load are possible without negatively impacting shutdown behavior.

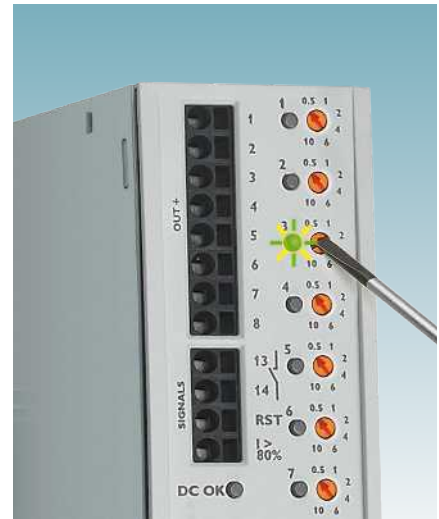

## Analysis and signaling

The currents flowing are constantly monitored. The CBM not only features a potential-free signal contact to indicate capacity utilization, it also has an 80% output. You are alerted as soon as at least one channel is being heavily utilized. The channel that has been switched off can be easily switched back on remotely via the Reset RST signal input. An LED also provides a message directly on the device.

Differentiate between undervoltages and overvoltages in your system to increase your system availability. The channels are shut down in the event of an error in the operating voltage and the system is switched to a defined state. The error is signaled directly via the remote indication contact. An LED also provides a message directly on the device.

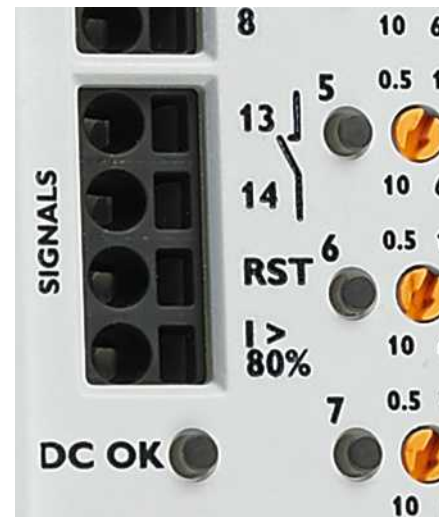





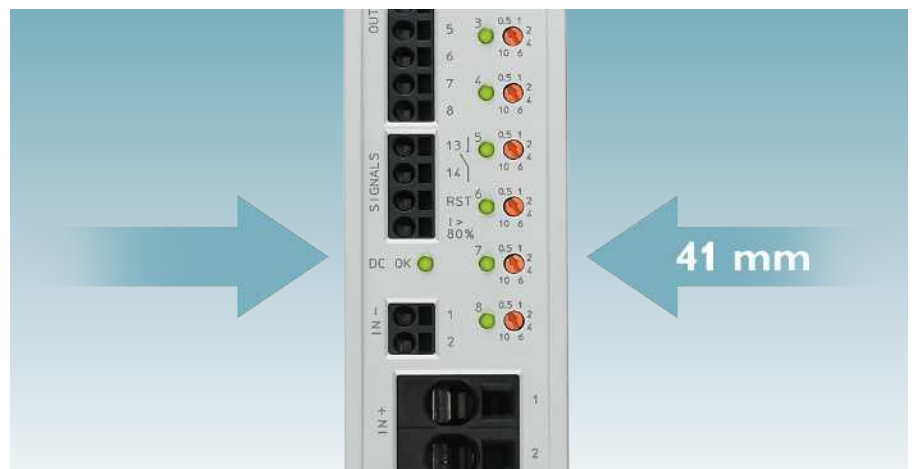

## 8 channels in a narrow installation space

Save space in the control cabinet with the 8-channel CBM E8 device circuit breaker. Reliably protect eight channels against overload and short-circuit currents in just one device with an overall width of only 41 mm. Reduce inventory costs and also ensure high flexibility in system planning.



# Multi-channel circuit breakers

Compact with tool-free adjustability		
CBMC – compact, with N/O contact (normally open)		
		
<b>Rated current</b>	<b>1 / 2 / 3 / 4 A DC</b>	<b>1 / 2 / 3 / 4 / 5 / 6 / 7 / 8 / 9 / 10 A DC</b>
Approvals		
Number of channels	4-channel	
Number of positions	1-pos.	
Operating voltage	24 V DC	
Backup fuse	4 A DC	15 A DC
Connection cross-section	Main circuit IN+: 0.25 mm <sup>2</sup> ... 6 mm <sup>2</sup> Main circuit IN-: 0.25 mm <sup>2</sup> ... 2.5 mm <sup>2</sup> Main circuit OUT: 0.25 mm <sup>2</sup> ... 2.5 mm <sup>2</sup>	
W x H x D in mm	36 x 90 x 98	
Type	CBMC E4 24DC/ 1-4A NO	CBMC E4 24DC/ 1-10A NO
Item no.	2906031	2906032
CBMC – compact, with N/O contact (normally open), available preconfigured		
		
<b>Rated current</b>	<b>1 / 2 / 3 / 4 A DC</b>	<b>1 / 2 / 3 / 4 / 5 / 6 / 7 / 8 / 9 / 10 A DC</b>
Approvals		
Number of channels	4-channel	
Number of positions	1-pos.	
Operating voltage	24 V DC	
Backup fuse	4 A DC	15 A DC
Connection cross-section	Main circuit IN+: 0.25 mm <sup>2</sup> ... 6 mm <sup>2</sup> Main circuit IN-: 0.25 mm <sup>2</sup> ... 2.5 mm <sup>2</sup> Main circuit OUT: 0.25 mm <sup>2</sup> ... 2.5 mm <sup>2</sup>	
W x H x D in mm	36 x 90 x 98	
Type	CBMC E4 24DC/ 1-4A NO-C	CBMC E4 24DC/ 1-10A NO-C
Item no.	2908713	2908716







# Multi-channel circuit breakers

1





2

3





Electronic circuit breakers

Compact with tool-free adjustability		
CBMC – compact, with status output and reset input		
		
<b>Rated current</b>	<b>1 / 2 / 3 / 4 A DC</b>	<b>1 / 2 / 3 / 4 / 5 / 6 / 7 / 8 / 9 / 10 A DC</b>
Approvals		
Number of channels	4-channel	
Number of positions	1-pos.	
Operating voltage	24 V DC	
Backup fuse	4 A DC	15 A DC
Connection cross-section	Main circuit IN+: 0.25 mm <sup>2</sup> ... 6 mm <sup>2</sup> Main circuit IN-: 0.25 mm <sup>2</sup> ... 2.5 mm <sup>2</sup> Main circuit OUT+: 0.25 mm <sup>2</sup> ... 2.5 mm <sup>2</sup>	
W x H x D in mm	36 x 90 x 98	
Type	CBMC E4 24DC/ 1-4A S-R	CBMC E4 24DC/ 1-10A S-R
Item no.	1065727	1065729
CBMC – compact, with status output and reset input, available preconfigured		
		
<b>Rated current</b>	<b>1 / 2 / 3 / 4 A DC</b>	<b>1 / 2 / 3 / 4 / 5 / 6 / 7 / 8 / 9 / 10 A DC</b>
Approvals		
Number of channels	4-channel	
Number of positions	1-pos.	
Operating voltage	24 V DC	
Backup fuse	4 A DC	15 A DC
Connection cross-section	Main circuit IN+: 0.25 mm <sup>2</sup> ... 6 mm <sup>2</sup> Main circuit IN-: 0.25 mm <sup>2</sup> ... 2.5 mm <sup>2</sup> Main circuit OUT+: 0.25 mm <sup>2</sup> ... 2.5 mm <sup>2</sup>	
W x H x D in mm	36 x 90 x 98	
Type	CBMC E4 24DC/ 1-4A S-R-C	CBMC E4 24DC/ 1-10A S-R-C
Item no.	1103876	1103875

# Multi-channel circuit breakers

Compact with tool-free adjustability	
	<b>CBMC – compact, with IO-Link interface</b>
	 
<b>Rated current</b>	<b>1 / 2 / 3 / 4 A DC</b> <b>1 / 2 / 3 / 4 / 5 / 6 / 7 / 8 / 9 / 10 A DC</b>
Approvals	
Number of channels	4-channel
Number of positions	1-pos.
Operating voltage	24 V DC
Backup fuse	15 A DC
Connection cross-section	Main circuit IN+: 0.25 mm <sup>2</sup> ... 6 mm <sup>2</sup> Main circuit IN-: 0.25 mm <sup>2</sup> ... 2.5 mm <sup>2</sup> Main circuit OUT: 0.25 mm <sup>2</sup> ... 2.5 mm <sup>2</sup>
W x H x D in mm	36 x 90 x 98
Type	CBMC E4 24DC/ 1-4A+ IOL                      CBMC E4 24DC/ 1-10A IOL
Item no.	<a href="#">2910410</a> <a href="#">2910411</a>
	<b>CBMC – compact, electrically isolating with N/O contact (normally open)</b>
	
<b>Rated current</b>	<b>1 / 2 / 3 / 4 / 5 / 6 / 7 / 8 A DC</b>
Number of channels	4-channel
Number of positions	1-pos.
Operating voltage	24 V DC
Backup fuse	15 A DC
Connection cross-section	Main circuit IN+: 0.25 mm <sup>2</sup> ... 6 mm <sup>2</sup> Main circuit IN-: 0.25 mm <sup>2</sup> ... 2.5 mm <sup>2</sup> Main circuit OUT: 0.25 mm <sup>2</sup> ... 2.5 mm <sup>2</sup>
W x H x D in mm	36 x 90 x 98
Type	CBMC EG4 24DC/ 1-8A NO
Item no.	<a href="#">1065730</a>

# Multi-channel circuit breakers

Highly functional and space saving		
	CBM – with status output, reset input and I >80% signaling	
		
<b>Rated current</b>	<b>0.5 / 1 / 2 / 4 / 6 / 10 A DC</b>	
Approvals	  	
Number of channels	4-channel	8-channel
Number of positions	1-pos.	
Operating voltage	24 V DC	
Backup fuse	15 A DC	
Connection cross-section	Main circuit IN+: 0.75 mm <sup>2</sup> ... 16 mm <sup>2</sup> Main circuit IN-: 0.25 mm <sup>2</sup> ... 2.5 mm <sup>2</sup> Main circuit OUT: 0.25 mm <sup>2</sup> ... 2.5 mm <sup>2</sup>	
W x H x D in mm	41 x 130 x 121	
Type	CBM E4 24DC/ 0.5-10A NO-R	CBM E8 24DC/ 0.5-10A NO-R
Item no.	<a href="#">2905743</a>	<a href="#">2905744</a>

# Thermal-magnetic device circuit breakers

2

Always the right choice – whether with basic functionality or highly functional. Our thermal-magnetic device circuit breakers are used in information, communication, and process technology. Due to the different tripping characteristics, the device circuit breakers can be used in a wide range of applications. Integrated remote signaling enables you to permanently monitor the operating state of your system.

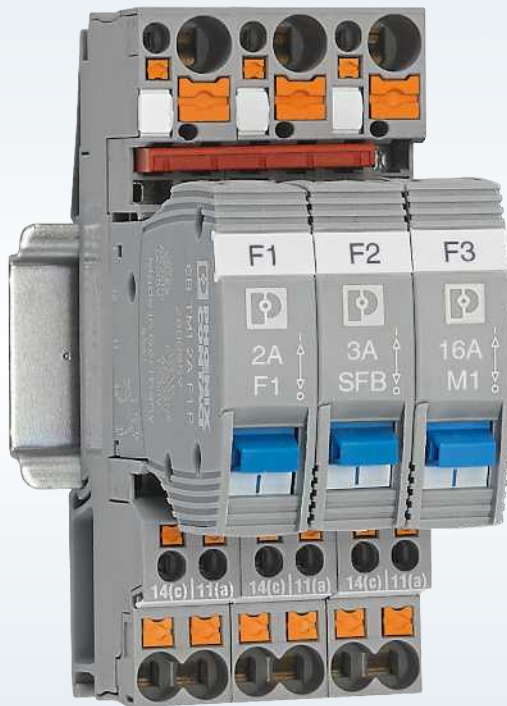

## CB TM

When you opt for the CB TM device circuit breakers, three tripping characteristics are available for different applications.

More information starting on page 38

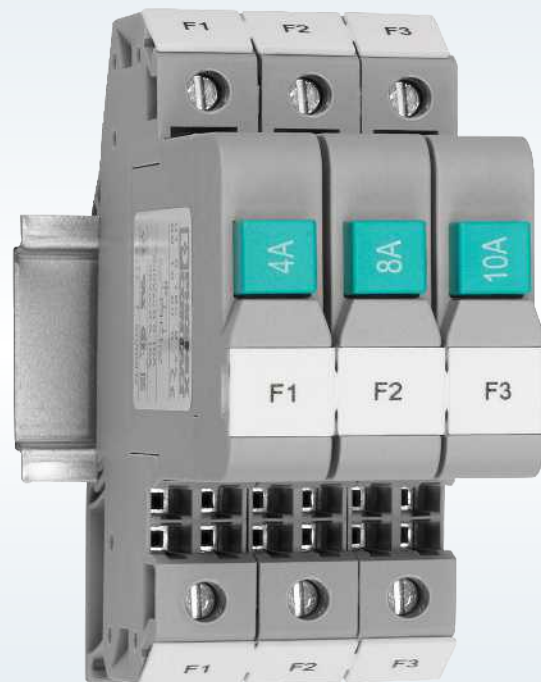

## UT 6-TMC

The UT 6-TMC device circuit breaker can be reset and features a generous marking area.

More information starting on page 44



# Thermal-magnetic device circuit breakers

## Using thermal-magnetic device circuit breakers

Thermal-magnetic device circuit breakers are used among other things in information and communication technology as well as process control. With a variety of versions with different tripping characteristics, the circuit breakers are ideally suited for protecting programmable logic controllers, valves, motors, and frequency converters.

The reactivation and immediate remote signaling of the operating state ensure high availability. The different characteristic curves for this protection technology can even start critical loads while at the same time providing secure protection in nominal operation.



## Tripping characteristics

### SFB characteristic curve

Circuit breakers with the SFB tripping characteristic offer maximum overcurrent protection, even in large systems with long cable paths. SFB stands for “selective fuse breaking,” i.e., selective shutdown. Protective devices with this characteristic curve prevent unnecessarily early switch-off in the event of brief current increases and starting currents during operation, for example. They simultaneously prevent unnecessarily long, persistent overload currents, which may lead to the dangerous generation of heat in operating equipment.

### M1 characteristic curve

Circuit breakers with the M1 characteristic curve trip later than those with SFB or F1 characteristic curves. They withstand starting currents for somewhat longer periods but consciously respond less swiftly to fault situations. In comparison to the direct current characteristic curve, the alternating current characteristic curve is dragged forward on the axis of the nominal current multiple. Even at a lower multiple of the nominal current, alternating currents cause the circuit breaker to trip.

### F1 characteristic curve

Circuit breakers with the F1 characteristic curve trip quickly. They react very quickly to overload situations. However, this can lead to unnecessary shutdowns during operation. This means they offer optimal protection for sensitive loads with very low starting current and thus provide protection over great distances. End devices, which can be damaged by temporary overloads and slightly increased operating current, are also protected by these circuit breakers.

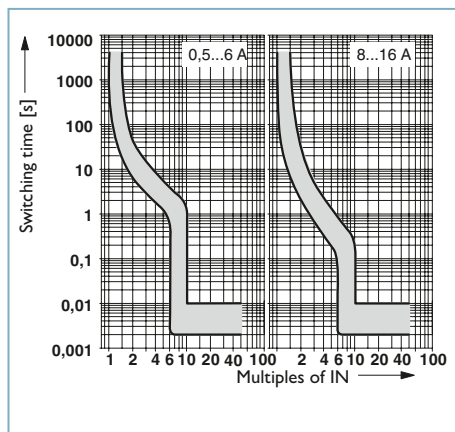

SFB characteristic curve

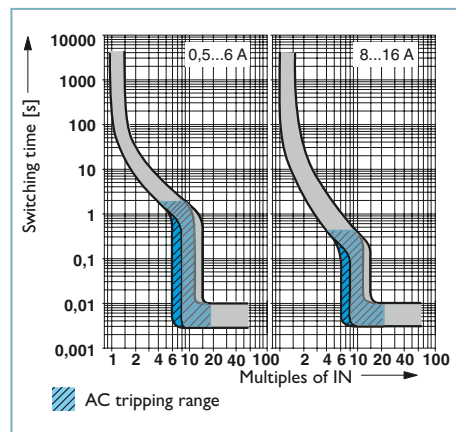

M1 characteristic curve

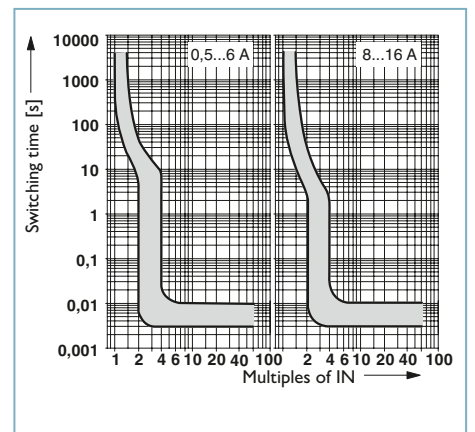

F1 characteristic curve

## Thermal-magnetic device circuit breakers

# Pluggable and customizable circuit breakers

Protect your application reliably against overload and short-circuit currents with the CB TM device circuit breakers. A large range of many different protective plugs is available for customizing your protection. Take advantage of the numerous features.

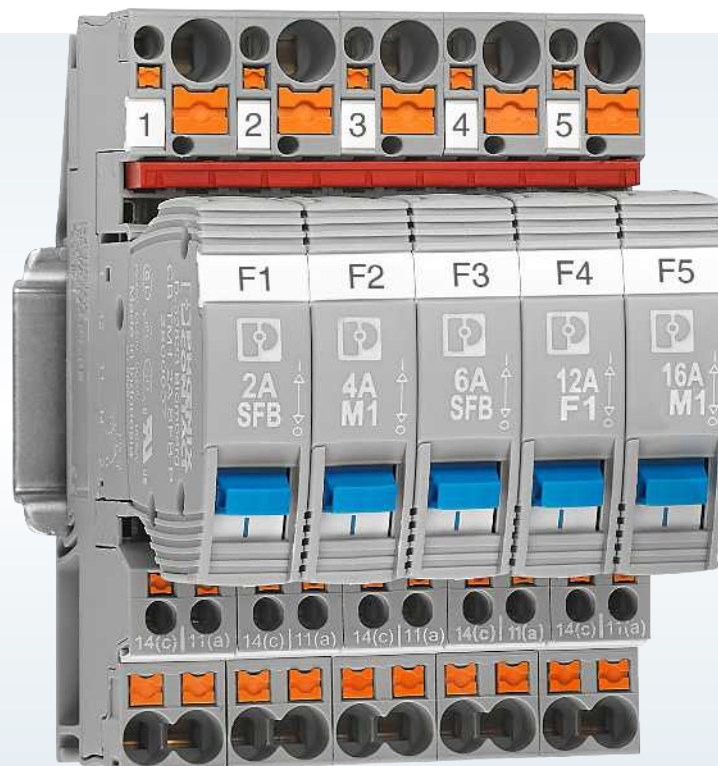

### Your advantages

- ✓ Individually adjustable with protective plugs
- ✓ Easy characteristic curve selection: choose between three different characteristics
- ✓ A large selection of protective plugs with fixed nominal current values for protection against unauthorized changes

## Customizable

Pre-wire systems and control cabinets with base elements. Simply install the appropriate protective plug to suit your individual requirements at a later date. If the demands placed on a load change in the meantime, you can simply replace the protective plug. The secure latching ensures that the plug remains firmly in place, even in harsh environments.

### Large selection of current values

A large selection of protective plugs is available in the CB TM range. The nominal currents range from 0.5 to 16 A. Select the right protective plug for your area of application. With the fixed, unchangeable nominal currents of the plugs, you can increase the security of your system. This prevents unintentional changes to the channel currents.

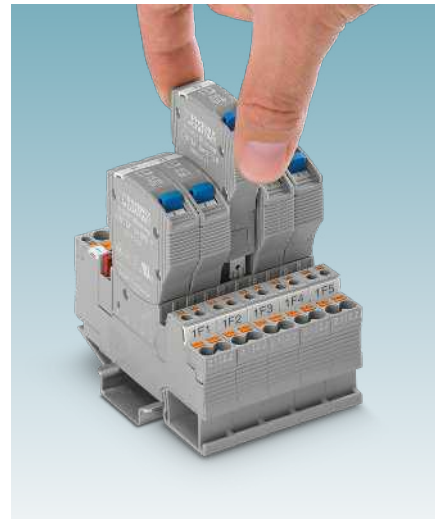

## Device circuit breakers with SFB characteristic curve

Thermal-magnetic device circuit breakers with SFB tripping characteristic provide maximum overcurrent protection – even in large systems with long cable paths.

Protective devices with this characteristic curve prevent unnecessary prior shutdown in the event of brief current increases during operation. They simultaneously prevent lengthy overload currents, which may lead to the hazardous generation of heat in operating equipment.

This tripping characteristic was specifically developed for use with power supplies that operate on the basis of SFB Technology.

Combining these two devices ensures particularly reliable tripping in the event of a fault, even in the case of long cable runs between the power supply and end device. The SFB characteristic curve is based on characteristic C, but its tolerance is significantly narrower. The circuit breaker therefore reaches its tripping current faster and is tripped sooner. This limits the short-circuit current and reduces the load on cables and connected devices.



## Quick and easy installation



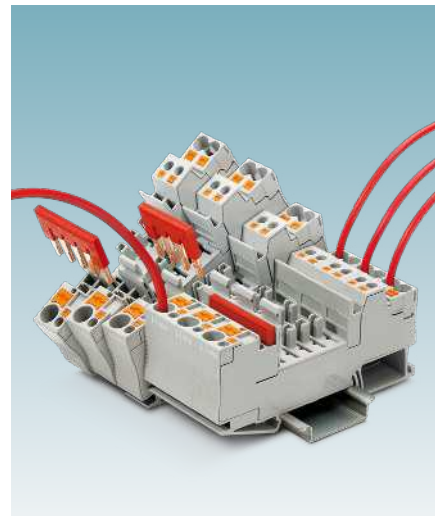

The device circuit breakers can be easily combined using the unique bridging system from our standard range. Potentials of the same type can be connected quickly and safely. Push-in connection technology enables you to wire the devices tool-free. This saves time and costs during installation.

### 1- and 2-pos. plugs

Ideal protection for your application. Plugs with various numbers of positions are available for this. Choose single-position plugs for the protection of grounded systems. Use our two-position plug to provide protection across all poles, as is required in insulated systems, for example. This way, you can ensure optimal protection for your system.



# Thermal-magnetic circuit breakers

Pluggable and customizable											
CB TM – with SFB characteristic curve, 1 changeover contact											
											
<b>Rated current</b>	<b>0.5 A</b>	<b>1 A</b>	<b>2 A</b>	<b>3 A</b>	<b>4 A</b>	<b>5 A</b>	<b>6 A</b>	<b>8 A</b>	<b>10 A</b>	<b>12 A</b>	<b>16 A</b>
Approvals											
Number of positions	1-pos.										
Operating voltage	50 V DC										
W x H x D in mm	12.3 x 45 x 52										
Type	CB TM1 0.5A SFB P	CB TM1 1A SFB P	CB TM1 2A SFB P	CB TM1 3A SFB P	CB TM1 4A SFB P	CB TM1 5A SFB P	CB TM1 6A SFB P	CB TM1 8A SFB P	CB TM1 10A SFB P	CB TM1 12A SFB P	CB TM1 16A SFB P
Item no.	2800835	2800836	2800837	2800838	2800839	2800840	2800841	2800842	2800843	2800844	2800845
CB TM – with SFB characteristic curve, 2 changeover contacts											
											
<b>Rated current</b>	<b>0.5 A</b>	<b>1 A</b>	<b>2 A</b>	<b>3 A</b>	<b>4 A</b>	<b>5 A</b>	<b>6 A</b>	<b>8 A</b>	<b>10 A</b>	<b>12 A</b>	<b>16 A</b>
Approvals											
Number of positions	2-pos.										
Operating voltage	80 V DC										
W x H x D in mm	24.6 x 45 x 52										
Type	CB TM2 0.5A SFB P	CB TM2 1A SFB P	CB TM2 2A SFB P	CB TM2 3A SFB P	CB TM2 4A SFB P	CB TM2 5A SFB P	CB TM2 6A SFB P	CB TM2 8A SFB P	CB TM2 10A SFB P	CB TM2 12A SFB P	CB TM2 16A SFB P
Item no.	2800868	2800869	2800870	2800871	2800872	2800873	2800874	2800875	2800876	2800877	2800878





# Thermal-magnetic circuit breakers

1





2

3

Thermal-magnetic device circuit breakers

Pluggable and customizable											
CB TM – with M1 characteristic curve, 1 changeover contact											
											
<b>Rated current</b>	<b>0.5 A</b>	<b>1 A</b>	<b>2 A</b>	<b>3 A</b>	<b>4 A</b>	<b>5 A</b>	<b>6 A</b>	<b>8 A</b>	<b>10 A</b>	<b>12 A</b>	<b>16 A</b>
Approvals											
Number of positions	1-pos.										
Operating voltage	240 V AC / 50 V DC										
W x H x D in mm	12.3 x 45 x 52										
Type	CB TM1 0.5A M1 P	CB TM1 1A M1 P	CB TM1 2A M1 P	CB TM1 3A M1 P	CB TM1 4A M1 P	CB TM1 5A M1 P	CB TM1 6A M1 P	CB TM1 8A M1 P	CB TM1 10A M1 P	CB TM1 12A M1 P	CB TM1 16A M1 P
Item no.	2800846	2800847	2800848	2800849	2800850	2800851	2800852	2800853	2800854	2800855	2800856
CB TM – with M1 characteristic curve, 2 changeover contacts											
											
<b>Rated current</b>	<b>0.5 A</b>	<b>1 A</b>	<b>2 A</b>	<b>3 A</b>	<b>4 A</b>	<b>5 A</b>	<b>6 A</b>	<b>8 A</b>	<b>10 A</b>	<b>12 A</b>	<b>16 A</b>
Approvals											
Number of positions	2-pos.										
Operating voltage	240 V AC / 80 V DC										
W x H x D in mm	24.6 x 45 x 52										
Type	CB TM2 0.5A M1 P	CB TM2 1A M1 P	CB TM2 2A M1 P	CB TM2 3A M1 P	CB TM2 4A M1 P	CB TM2 5A M1 P	CB TM2 6A M1 P	CB TM2 8A M1 P	CB TM2 10A M1 P	CB TM2 12A M1 P	CB TM2 16A M1 P
Item no.	2800879	2800880	2800881	2800882	2800883	2800884	2800885	2800886	2800887	2800888	2800889

# Thermal-magnetic circuit breakers

Pluggable and customizable											
CB TM – with F1 characteristic curve, 1 changeover contact											
											
<b>Rated current</b>	<b>0.5 A</b>	<b>1 A</b>	<b>2 A</b>	<b>3 A</b>	<b>4 A</b>	<b>5 A</b>	<b>6 A</b>	<b>8 A</b>	<b>10 A</b>	<b>12 A</b>	<b>16 A</b>
Approvals											
Number of positions	1-pos.										
Operating voltage	50 V DC										
W x H x D in mm	12.3 x 45 x 52										
Type	CB TM1 0.5A F1 P	CB TM1 1A F1 P	CB TM1 2A F1 P	CB TM1 3A F1 P	CB TM1 4A F1 P	CB TM1 5A F1 P	CB TM1 6A F1 P	CB TM1 8A F1 P	CB TM1 10A F1 P	CB TM1 12A F1 P	CB TM1 16A F1 P
Item no.	2800857	2800858	2800859	2800860	2800861	2800862	2800863	2800864	2800865	2800866	2800867
CB TM – with F1 characteristic curve, 2 changeover contacts											
											
<b>Rated current</b>	<b>0.5 A</b>	<b>1 A</b>	<b>2 A</b>	<b>3 A</b>	<b>4 A</b>	<b>5 A</b>	<b>6 A</b>	<b>8 A</b>	<b>10 A</b>	<b>12 A</b>	<b>16 A</b>
Approvals											
Number of positions	2-pos.										
Operating voltage	80 V DC										
W x H x D in mm	24.6 x 45 x 52										
Type	CB TM2 0.5A F1 P	CB TM2 1A F1 P	CB TM2 2A F1 P	CB TM2 3A F1 P	CB TM2 4A F1 P	CB TM2 5A F1 P	CB TM2 6A F1 P	CB TM2 8A F1 P	CB TM2 10A F1 P	CB TM2 12A F1 P	CB TM2 16A F1 P
Item no.	2800890	2800891	2800892	2800893	2800894	2800895	2800896	2800897	2800898	2800899	2800900





# Thermal-magnetic circuit breakers

1

2

3

Thermal-magnetic device circuit breakers

Necessary accessories for CB TM			
	Base element		
			
<b>Connection technology</b>	<b>Push-in connection</b>	<b>Screw connection</b>	<b>Solder connection</b>
Approvals			
Mounting type	DIN rail: 35 mm		On PCB
Connection cross-section	Connection 1: 0.5 mm <sup>2</sup> ... 6 mm <sup>2</sup> Connection 2.1 / 2.2: 0.2 mm <sup>2</sup> ... 4 mm <sup>2</sup> Connection 12 / 11 / 14: 0.14 mm <sup>2</sup> ... 1.5 mm <sup>2</sup>	Connection 1: 0.5 mm <sup>2</sup> ... 10 mm <sup>2</sup> Connection 2: 0.5 mm <sup>2</sup> ... 10 mm <sup>2</sup> Connection 12 / 11 / 14: 0.14 mm <sup>2</sup> ... 2.5 mm <sup>2</sup>	
W x H x D in mm	12.3 x 90 x 46.7	12.3 x 90.8 x 70	12.3 x 34.8 x 36.4
Type	CB 1/6-2/4 PT-BE	CB 1/10-1/10 UT-BE	CB S-BE
Item no.	<a href="#">2800929</a>	<a href="#">2801305</a>	<a href="#">2905067</a>



## Thermal-magnetic device circuit breakers

# One-piece and modular, extendable circuit breakers

The UT 6-TMC device circuit breakers provide optimal basic protection. With their thermal-magnetic characteristic curve, which is available in various nominal currents, they reliably protect loads and cables against overload and short-circuit currents.

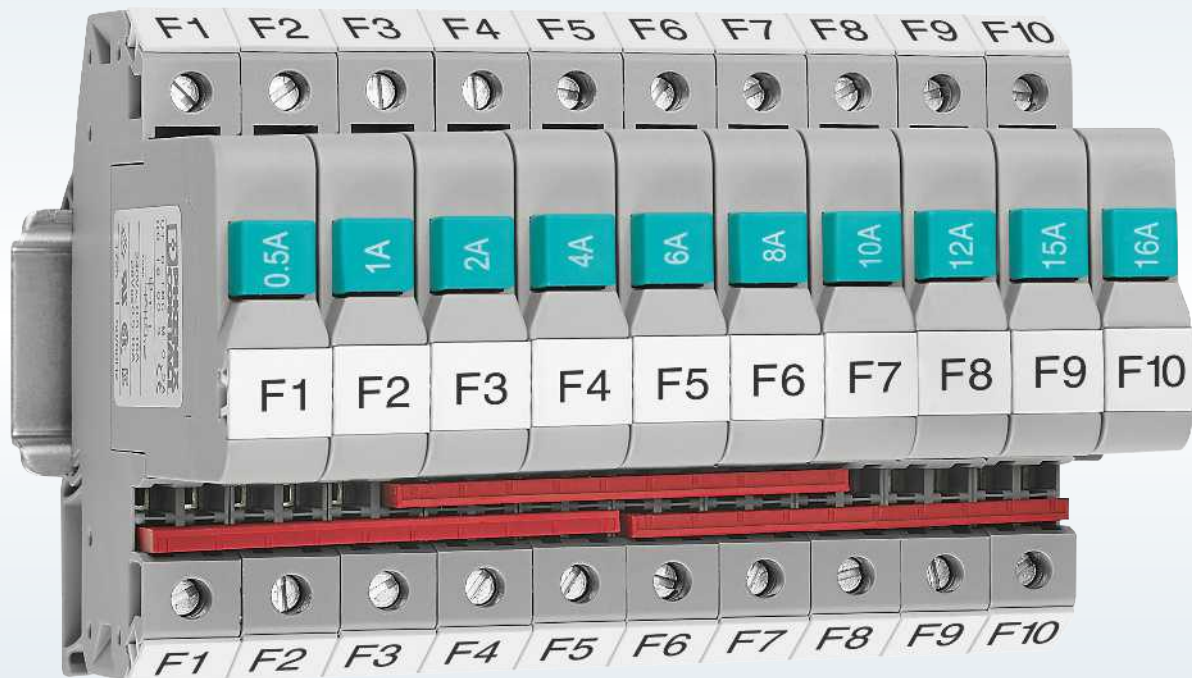

### Your advantages

- ✓ Simple feed-in with bridging capability using CLIPLINE complete accessories
- ✓ High system availability with easy resetting
- ✓ Quick and easy identification with large-area marking options

## Simple feed-in

Feed-in to the UT 6-TMC is simple with the double bridge shaft. Systems can also be extended quickly and easily. You can use standard accessories from the CLIPLINE complete range, and do not need to qualify any new materials.

### Quick and easy identification

Each circuit can be clearly marked. The UT 6-TMC device circuit breaker features versatile and large-area marking options for this. Individual circuits can be quickly identified at a glance. This simplifies troubleshooting.

### Compact design

The UT 6-TMC feature a narrow design with a width of just 12.3 mm. With this compactness, you save 30% space in the control cabinet compared to standard miniature circuit breakers.

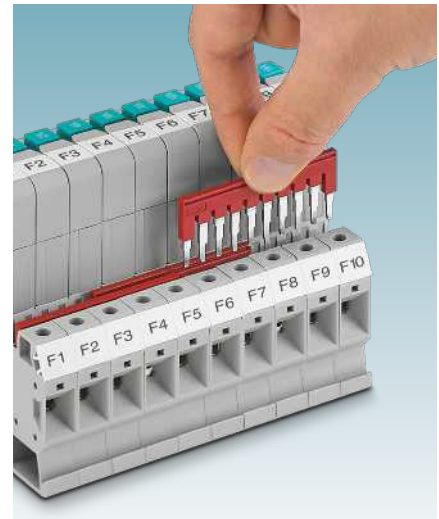

## High system availability

Device replacement is not necessary in the event of an error. The system is easy to reset and can therefore be quickly restarted. The trip-free mechanism prevents blocking of the shutdown.

### Large nominal current range

The device circuit breakers are available in 11 nominal current levels. With a nominal current range of 0.5 to 16 A, you are sure to find the appropriate device for your application.

### Connection technology

Take advantage of many years of experience in connection technology with the proven screw connection technology of the UT 6-TMC products.

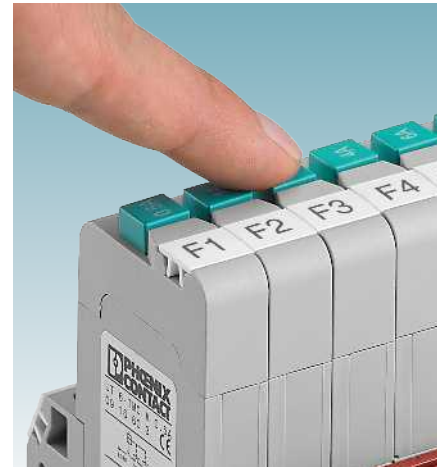

## One-piece and modular extension possible

### UT 6 TMC – with M characteristic curve, 1 changeover contact



Rated current	0.5 A	1 A	2 A	4 A	5 A	6 A	8 A	10 A	12 A	15 A	16 A
Approvals											
Number of positions	1-pos.										
Operating voltage	240 V AC / 28 V DC										
W x H x D in mm	12.3 x 85.5 x 89.5										
Type	UT 6-TMC M 0,5A	UT 6-TMC M 1A	UT 6-TMC M 2A	UT 6-TMC M 4A	UT 6-TMC M 5A	UT 6-TMC M 6A	UT 6-TMC M 8A	UT 6-TMC M 10A	UT 6-TMC M 12A	UT 6-TMC M 15A	UT 6-TMC M 16A
Item no.	0916603	0916604	0916605	0916606	0916607	0916608	0916609	0916610	0916611	0916612	0916613

# Thermal device circuit breakers

3

Thermal circuit breakers provide optimal protection against overload for your loads in power distribution systems. When the circuit breaker trips, the integrated switch function enables immediate reactivation. Unlike a fuse, the circuit breaker does not need to be replaced. The higher the overload, the faster the thermal device circuit breaker trips.

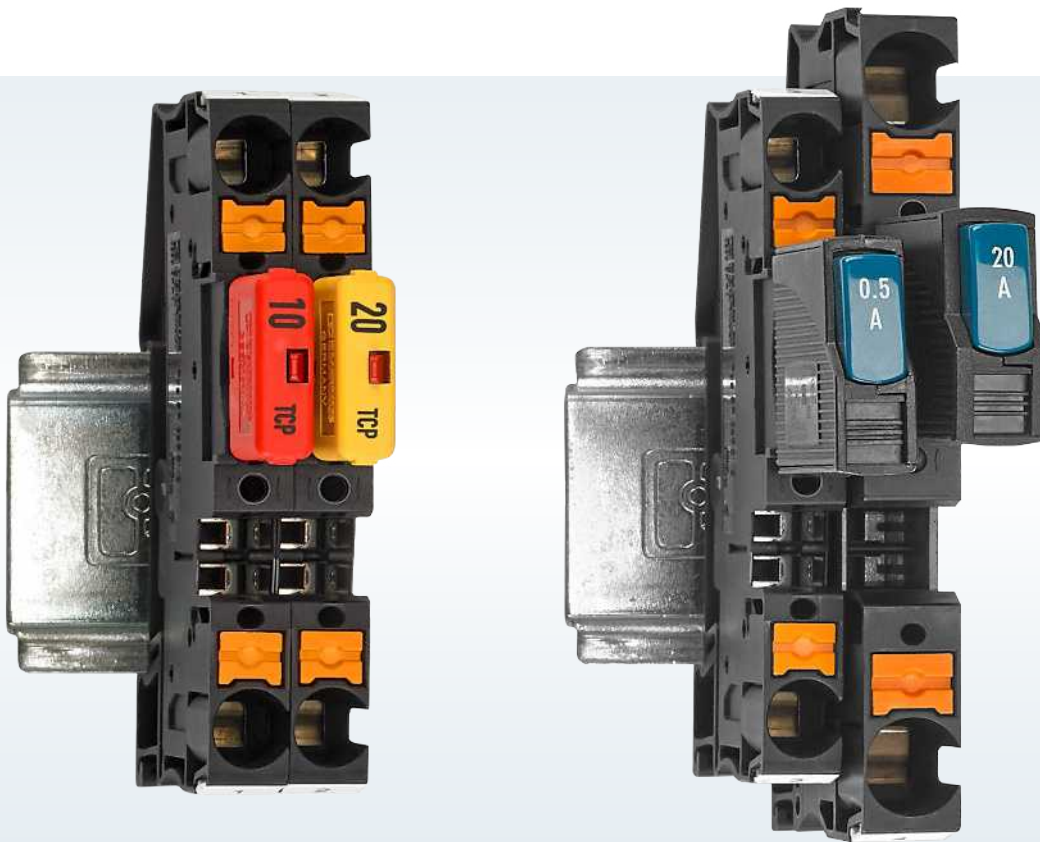

## Thermal device circuit breakers for the DC voltage range

The protective plugs can be reset and are suitable for applications up to 40 A DC.

More information starting on page 48

## Thermal device circuit breakers for the DC and AC voltage range

The protective plugs can be switched on and off and are used in applications up to 20 A AC.

More information starting on page 50

# Thermal device circuit breakers

## Field of application

Thermal device circuit breakers provide optimal protection against overload for inductive and resistive loads in power distribution systems, control cabinet engineering, and systems manufacturing. They are resistant to high starting currents like those that occur when starting a motor or switching on a transformer. They are also used for protecting circuits in battery and onboard systems. Compared to other protection technologies, however, thermal circuit breakers do not offer rapid protection from short circuits.

## Function

The tripping element of thermal device circuit breakers is bimetallic. It may also be a combination of bimetal and an electrical heating element. The bimetal consists of steel and zinc, which is deformed by heat. When a predefined heat level is reached as a result of an excessively high current in the heating element, the thermal bimetal trips the shutdown mechanism.

This thermal tripping element makes the thermal protection more susceptible to higher ambient temperatures. Thermal device circuit breakers represent a simple, cost-effective solution for applications which do not necessarily require fast and precise shutdown.

## Tripping characteristics

The tripping time of thermal device circuit breakers depends on the overload current that is flowing and the ambient temperature. The characteristic curves show that the tripping time is reached faster as the overload increases. With smaller overload currents, it therefore takes longer for the connected load to be disconnected from the power supply (Fig. 1).

For circuit breakers with different nominal currents but the same tripping characteristics, tripping behavior can also be visualized as characteristic curve fields (Fig. 2). Of course, thermal device circuit breakers respond to the effects of heat. The ambient temperature can also affect the tripping time. The circuit breaker trips more easily at a high ambient temperature and more slowly at a low ambient temperature. This behavior is indicated by additional characteristic curves with corresponding information.

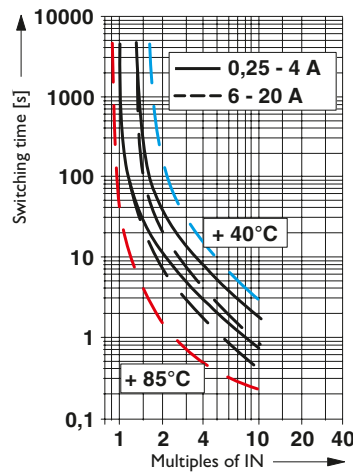

Typical tripping characteristics for thermal circuit breakers:

$\tau$  Switch time (in seconds)

xI Multiple of the nominal current/tripping factor

- 1 Current ranges of the characteristic field
- 2 Tripping characteristics of the lower temperature range (blue)
- 3 Tripping characteristics group 1
- 4 Tripping characteristics group 2
- 5 Tripping characteristics of the upper temperature range (red)

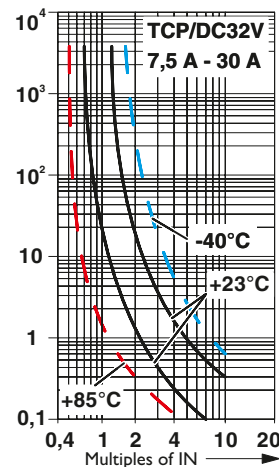
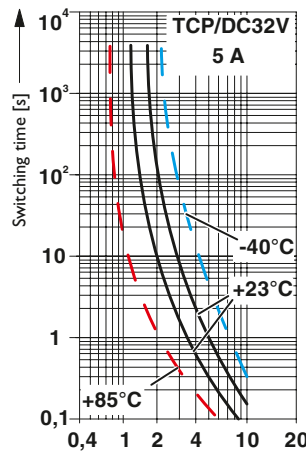

Two key characteristic curves of thermal circuit breakers

## Thermal device circuit breakers

### Space-saving basic protection









With their small design and low installation height, resettable TCP device circuit breakers are ideal for use in applications with limited installation space. The range of protective plugs can be distinguished by their color coding in the different rated currents. Installation is via direct connection of the plug-in base to a suitable and bridgeable terminal block.





#### Your advantages

- ✓ Suitable for all flat-type fuse inserts with standardized plug-in contacts
- ✓ Shorter downtimes with immediate reset after tripping
- ✓ Space-saving installation with a slim design

## Space-saving basic protection, can be reset

TCP – with 32 V DC nominal voltage								
								
<b>Rated current</b>	<b>5 A</b>	<b>7.5 A</b>	<b>10 A</b>	<b>15 A</b>	<b>20 A</b>	<b>25 A</b>	<b>30 A</b>	<b>40 A</b>
Number of positions	1-pos.							
Operating voltage	32 V DC							
W x H x D in mm	6 x 20.3 x 24							
Type	TCP 5/DC32V	TCP 7,5/DC32V	TCP 10/DC32V	TCP 15/DC32V	TCP 20/DC32V	TCP 25/DC32V	TCP 30/DC32V	TCP 40/DC32V
Item no.	0700005	0700007	0700010	0700015	0700020	0700025	0700030	0700040

## Necessary accessories for TCP 32 V DC and 65 V DC

Fuse terminal blocks									
									
<b>Connection technology</b>	<b>Push-in connection</b>			<b>Spring-cage connection</b>			<b>Screw connection</b>		
Nominal current	25 A			30 A					
Nominal voltage	400 V	12 V	24 V	400 V	12 V	24 V	250 V		
Connection cross-section	0.5 mm <sup>2</sup> ... 10 mm <sup>2</sup>			0.08 mm <sup>2</sup> ... 4 mm <sup>2</sup>			0.2 mm <sup>2</sup> ... 6 mm <sup>2</sup>		
Type	PT 6-FSI/C	PT 6-FSI/C-LED 12	PT 6-FSI/C-LED 24	ST 4-FSI/C	ST 4-FSI/C-LED 12	ST 4-FSI/C-LED 24	UK 6-FSI/C	UK 6-FSI/C-LED12	UK 6-FSI/C-LED24
Item no.	3212166	3212169	3212172	3036372	3036495	3036505	3118203	3001925	3001938

## Thermal device circuit breakers

# Basic protection for AC and DC applications

TCP device circuit breakers can be switched on and off again and are used in applications up to 250 V AC and 72 V DC. The products are ideal for replacing existing fuses with a switchable version. This minimizes maintenance work. Pluggable protective devices and potential distribution via the terminal blocks significantly reduce the installation work.



### Your advantages

- ✓ Suitable for all flat-type fuse inserts with standardized plug-in contacts
- ✓ Shorter downtimes with immediate reset after tripping
- ✓ Space-saving installation with a slim design



### Basic protection for AC and DC applications, can be reset

TCP – with 65 V DC nominal voltage											
											
<b>Rated current</b>	<b>0.1 A</b>	<b>0.25 A</b>	<b>0.5 A</b>	<b>1 A</b>	<b>2 A</b>	<b>3 A</b>	<b>4 A</b>	<b>6 A</b>	<b>8 A</b>	<b>10 A</b>	
Approvals											
Number of positions	1-pos.										
Operating voltage	250 V AC / 65 V DC										
W x H x D in mm	8.2 x 24.4 x 44.5										
Type	TCP 0,1A	TCP 0,25A	TCP 0,5A	TCP 1A	TCP 2A	TCP 3A	TCP 4A	TCP 6A	TCP 8A	TCP 10A	
Item no.	0712107	0712123	0712152	0712194	0712217	0712233	0712259	0712275	0712291	0712314	
TCP – with 72 V DC nominal voltage											
											
<b>Rated current</b>	<b>16 A</b>				<b>new</b>		<b>20 A</b>			<b>new</b>	
Approvals											
Number of positions	1-pos.										
Operating voltage	250 V AC / 72 V DC										
W x H x D in mm	9.5 x 24.4 x 44.5										
Type	TCP 10/16A					TCP 10/20A					
Item no.	1324402					1324401					

### Necessary accessories for TCP 72 V DC

Fuse terminal blocks	
	
<b>Connection technology</b>	<b>Push-in connection</b>
Nominal current	30 A
Nominal voltage	400 V
Connection cross-section	0.5 mm <sup>2</sup> ... 10 mm <sup>2</sup>
Type	PT 10-FSI/C
Item no.	1088498

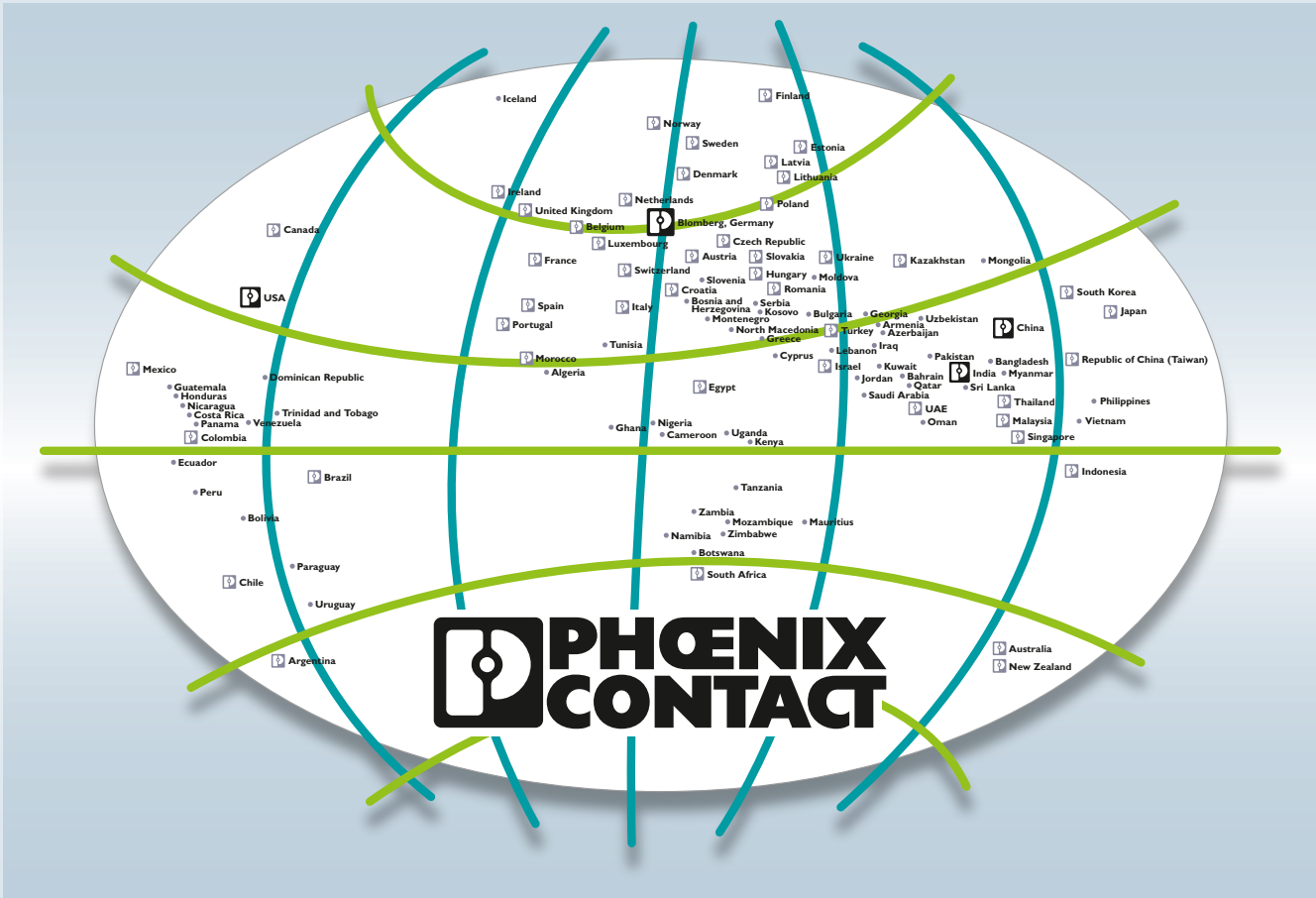

## Open communication with customers and partners worldwide

Phoenix Contact is a global market leader based in Germany. We are known for producing future-oriented products and solutions for the electrification, networking, and automation of all sectors of the economy and infrastructure. With a global network reaching across more than 100 countries with over 22,000 employees, we maintain close relationships with our customers, something we believe is essential for our common success.

Our wide range of innovative products makes it easy for our customers to implement the latest technology in a variety of applications and industries. This especially applies to the target markets of energy, infrastructure, industry, and mobility.

You can find your local partner at

[phoenixcontact.com](http://phoenixcontact.com)