

# NX-series Safety Controller

## CIP Safety System



Safety over  
EtherCAT®

# Quick, easy and flexible integration of production line safety



Scalable from large automotive production lines to small parts production lines

- Flexible safety system for large-scale production
  - Interlocking between various machines
- » Page 4



Quick and easy safety program design

- Reduce time required for design
  - Reduce time required for verification
- » Page 8



Efficient safety management and maintenance

- Minimize system downtime
  - Reduce maintenance work
- » Page 10

Manufacturers require flexible systems for global production and high-mix production. System designs have become more and more complicated because these flexible systems need safety control according to control programs. However, it is also required to reduce design and maintenance time to efficiently build various systems. In order to meet these needs, we offer a new CIP Safety system using the NX Safety Network Controller.

### Safety control for large systems



Communication Control Unit NX-CSG320    Safety CPU Unit NX-SL5500/5700

### High-speed safety control for mid-size systems



Machine Automation Controller NX-102    Safety CPU Unit NX-SL5500/5700



Safety I/O Terminal I/O model GI-SMD1624



Safety I/O Terminal Input model GI-SID1224



Automation Software Sysmac Studio SYSMAC-SE/FE

### EtherNet/IP

EtherNet/IP™ is a widely used and vendor-independent industrial Ethernet network that is managed by ODVA.



The Common Industrial Protocol (CIP™) is an industry standard open network, enabling seamless communication among CIP networks. CIP Safety™ adds safety functionality to CIP networks.

### EtherCAT

EtherCAT® is an industrial real-time communication network promoted by EtherCAT Technology Group (ETG).

### Safety over EtherCAT

Safety over EtherCAT (FSoE) allows a single communication system to be used for both control and safety data.

## Flexible safety system for large-scale production

### EtherNet/IP for safety across the world

Production systems have to meet worldwide standards because of the globalization of production. CIP Safety is a protocol for transmitting safety data via EtherNet/IP that is adopted by factory automation and robot manufacturers all over the world. Using CIP Safety, you can build globally standardized networks and simplify the global procurement of production systems.

### One connection using CIP Safety

Safety systems for industrial robots are becoming increasingly used; networks can be easily built with the NX-SL5 Safety CPU Units which support CIP Safety.



### EtherNet/IP brings flexibility

The NX-CSG Communication Control Unit with multiple network ports enables a safety network to be divided into several segments, making it easy to connect many network devices required for a large production line. This allows flexibility to add or remove devices from existing safety systems.

Safety control between lines :Port 1  
Robot control within process :Port 2A, 2B

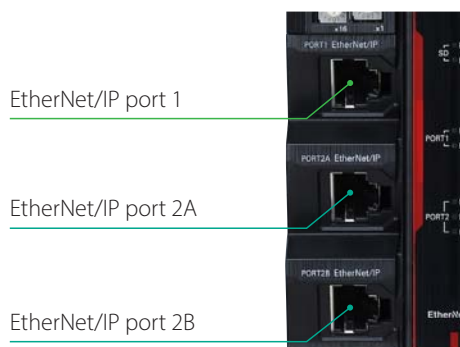

### Fast and fixed response cycle facilitates reconfiguration

Using the NX-CSG Communication Control Unit in conjunction with the NX-SL5 Safety CPU Unit provides safety communications via CIP Safety and at the same time provides local high-speed safety I/O control. With the fastest local I/O response time of 50 ms, the NX-SL5 Safety CPU Unit can be used for applications where a high level of responsiveness is required.

\* Calculate the response speed of your system taking the performance of I/O devices into consideration. Refer to the manual for details.

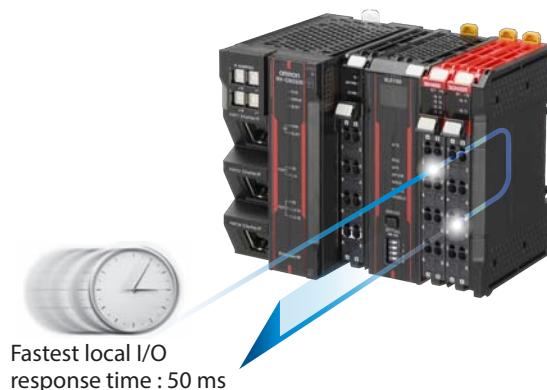

## Standardize the safety system network for a large robot system

### System configuration

In this example, devices and machines communicate via EtherNet/IP and CIP Safety in this system. Each process includes robots, safety light curtains, emergency stop switches, and other safety components. The NX-CSG Communication Control Unit and NX-SL5 Safety CPU Unit execute safety control programs in each process. CIP Safety is used for safety interlocking between processes and for building a safety control network across the system.

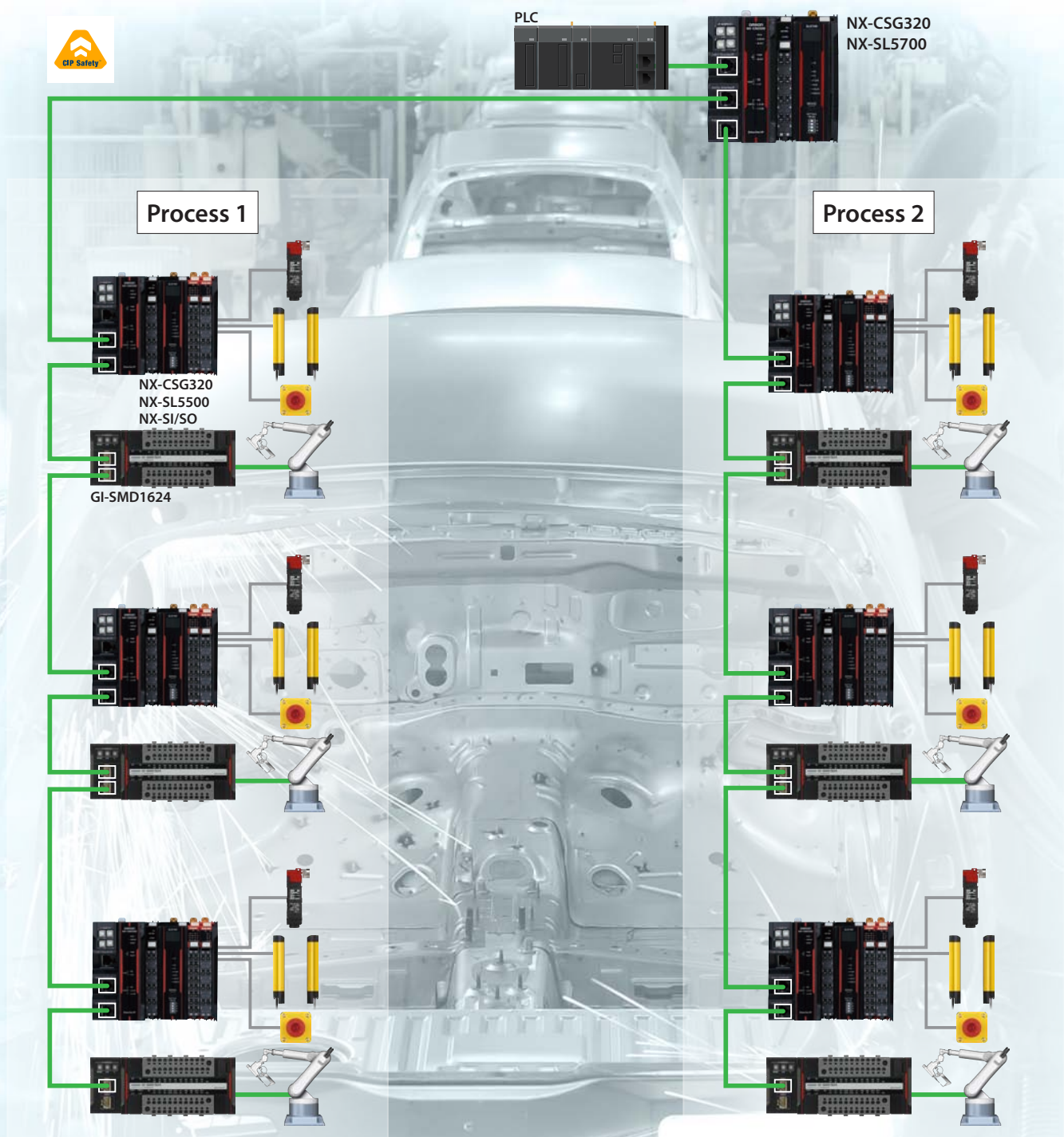

— EtherNet/IP — Hardware cabling  
— EtherNet/IP & CIP Safety

\* Understand the connection specifications of devices which are used in the system before creating a network.

# Interlocking between various machines

## Simple configuration

CIP Safety allows safety devices and standard devices to be mixed on the same network, providing safety interlock control between machines. CIP Safety robots and remote I/O terminals can be easily connected.

## Modular processes bring flexibility to line layouts

The NX-CSG320 Communication Control Unit and NX-SL5 Safety CPU Unit exchange interlock signals with other machines while implementing safety control within the machine. Programs for machine control and safety control can be created for each machine. This modularized design helps standardize design and improve design efficiency.

## Modular machines with individual CPU units

### System configuration

Machine 1 and 3 are processing machines with the control program and safety control program for each machine. Machine 2 is a material handling machine that transports products processed by Machine 1 and 3 to the next process. The NX-CSG320 Communication Control Unit and NX-SL5 Safety CPU Unit are used for all machines, and CIP Safety is used for safety interlocking between machines.

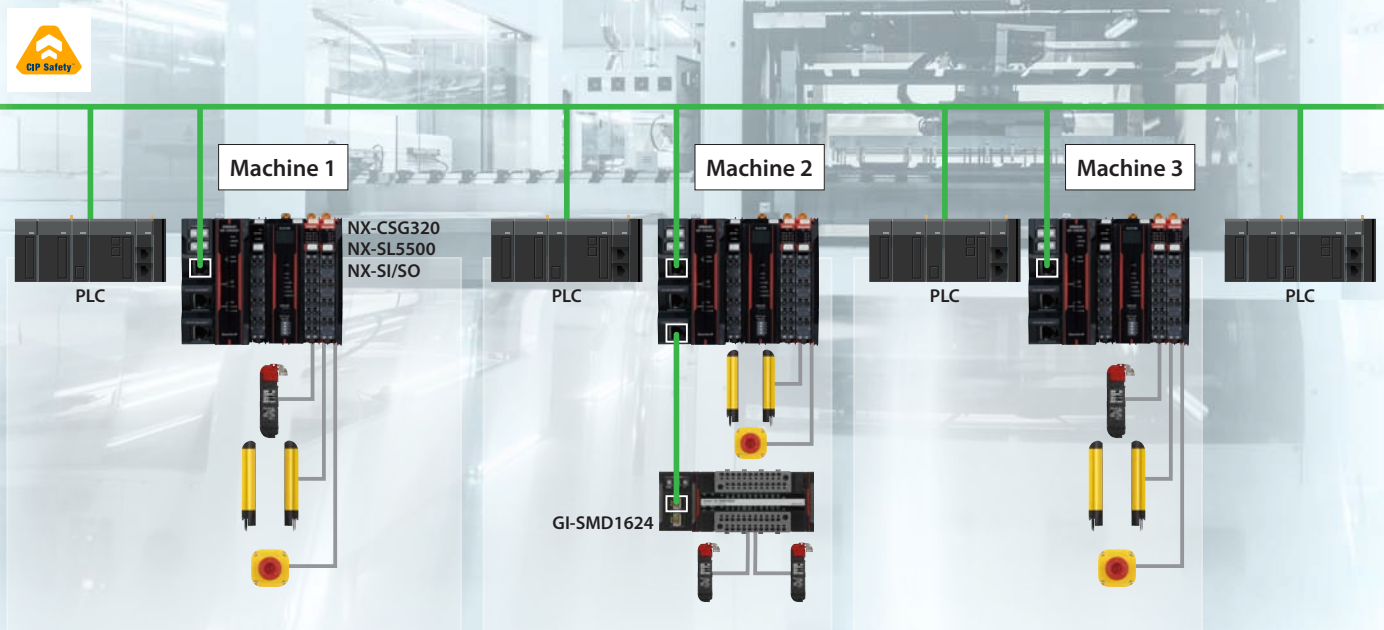

EtherNet/IP  
EtherNet/IP & CIP Safety



Hardware cabling

\* Understand the connection specifications of devices which are used in the system before creating a network.

## Two different networks in a single system

The NX-SL5 Safety CPU Unit connected with the NX102 Machine Automation Controller enables the use of both EtherCAT + FSoE (Safety over EtherCAT) and EtherNet/IP + CIP Safety at the same time.

In addition to interlock control within a machine via FSoE, safety interlock between machines can be implemented using CIP Safety.

### Integrated safety into high-speed machine control

The NX-SL5 Safety CPU Unit combination with the NX102 Machine Automation Controller , provides both safety control and machine control with fast cycle times.

By mounting the NX-SL Safety CPU Unit and safety I/O units to the NX102 and by connecting the servo drives via FSoE on EtherCAT, you can configure a simple motion and safety control system using high-speed networks.

### Line safety control and fast machine control at the same time

#### System configuration

The NX102 Machine Automation Controller and NX-SL5 Safety CPU Unit are used in Machine 1 and 2 to build a system with safety network and real-time control capabilities using EtherCAT. The machine status is reported to the host system and displayed on the HMI connected on the same network.

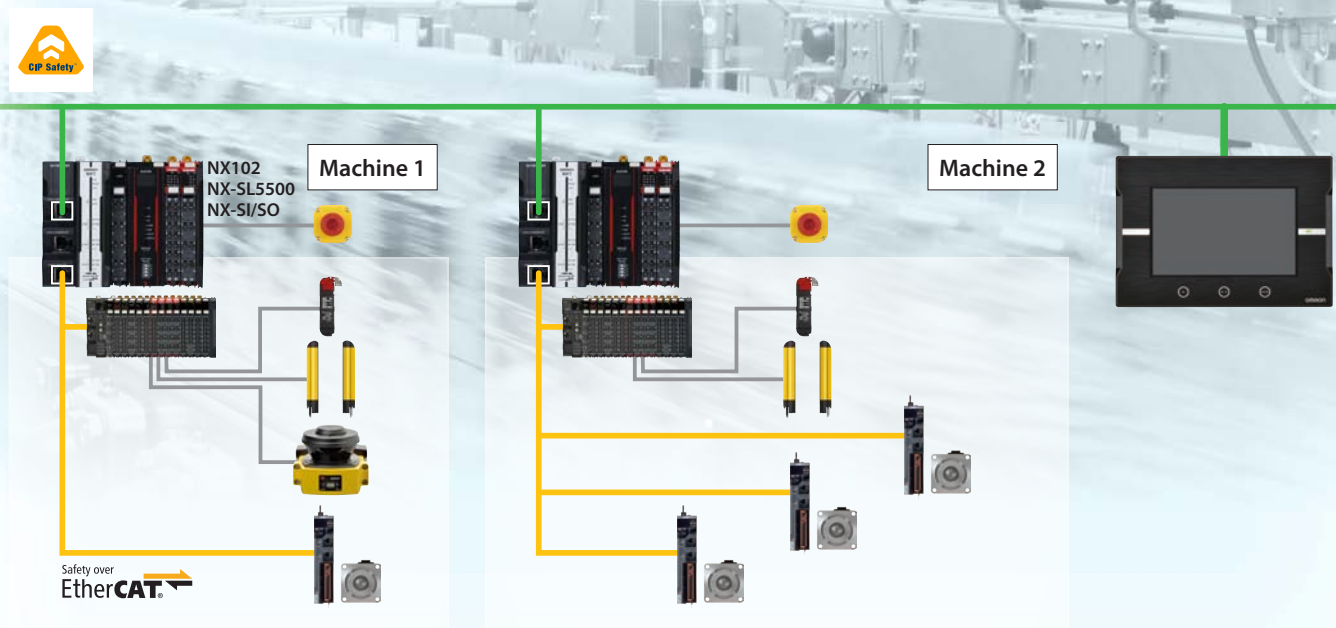

\* Understand the connection specifications of devices which are used in the system before creating a network.

## Improve design productivity

The Automation Software Sysmac Studio provides various functionalities to reduce time required for production system design and safety program verification.



### Design Reduce time required for production system design

#### Automatic Programming

Create a truth table using input, output, and stop conditions of safety devices to automatically create a safety program for a simple machine.

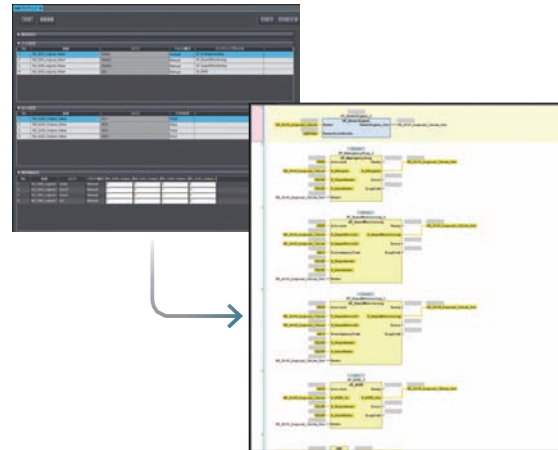

\* Programs created by Automatic Programming will not guarantee functional safety. Refer to the User's Manual (Cat. No. Z395) for details.

#### User-defined Function Block (FB)

Programs can be easily converted into a user-defined function block (FB); help files can be attached to describe input and output conditions as well as the functionality of the program within the function block (FB). Different security levels can be set to protect the function block from viewing and unauthorized modifications.

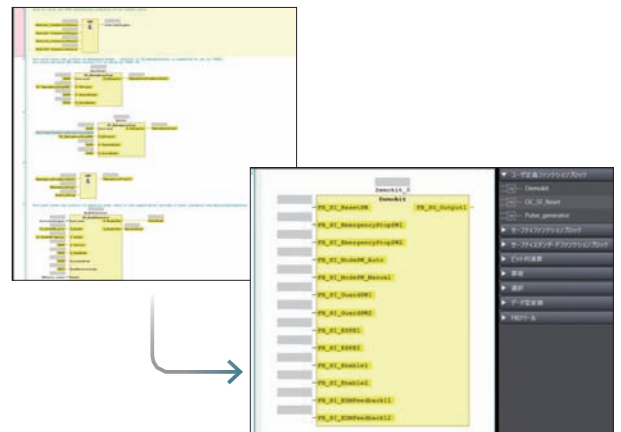

\* User-defined FBs can be used as modular software components according to the hardware configuration. They help standardize programs and maintain the consistency of design quality.



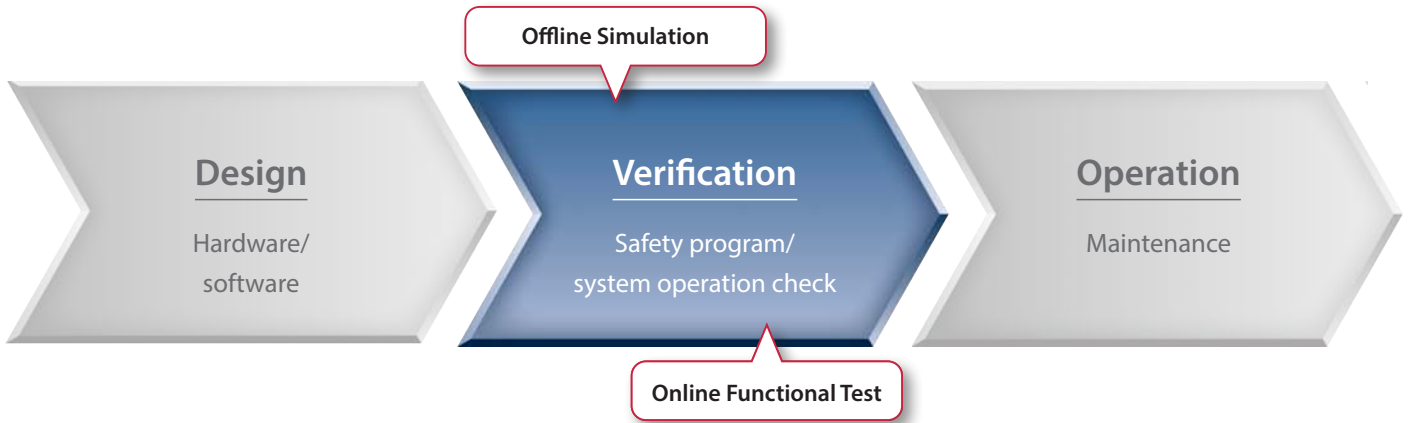

## Verification Implement safety management without experts

### Offline Simulation

Programs can be simulated on your PC, Sysmac Studio allows verification of programs without connecting hardware.



### Online Functional Test

Online Functional Test enables operation of safety functions to be checked when the NX-SL5 Safety CPU Unit is online with Sysmac Studio. The test results can be output as a report along with the safety signature; the safety signature is displayed on the seven-segment display of the NX-SL5 Safety CPU Unit, and can easily be checked if the configuration matches the report after the program has been validated.

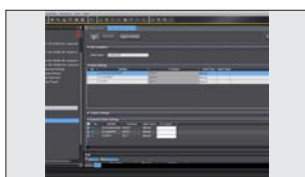

**[Preparation]**  
Start the Sysmac Studio and go online with the NX-SL5. Register the safety devices to test and set the expected values of each signal.



**[Testing]**  
Operate safety devices by following the instructions on the screen. Check if each device operates correctly and input the check results.



**[Tests completed]**  
The test results are listed after all tests have been completed. The list can be output as a CSV file.



**[Printing test results]**  
The test details, results, and executed date and time can be output as a PDF file. The names of the tester and approver can be added. The safety signature code, which identifies the validated program, is included at the bottom right of the report.

# Maintenance without PC

No PC is required for maintenance, which reduces production system maintenance work and minimizes system downtime.

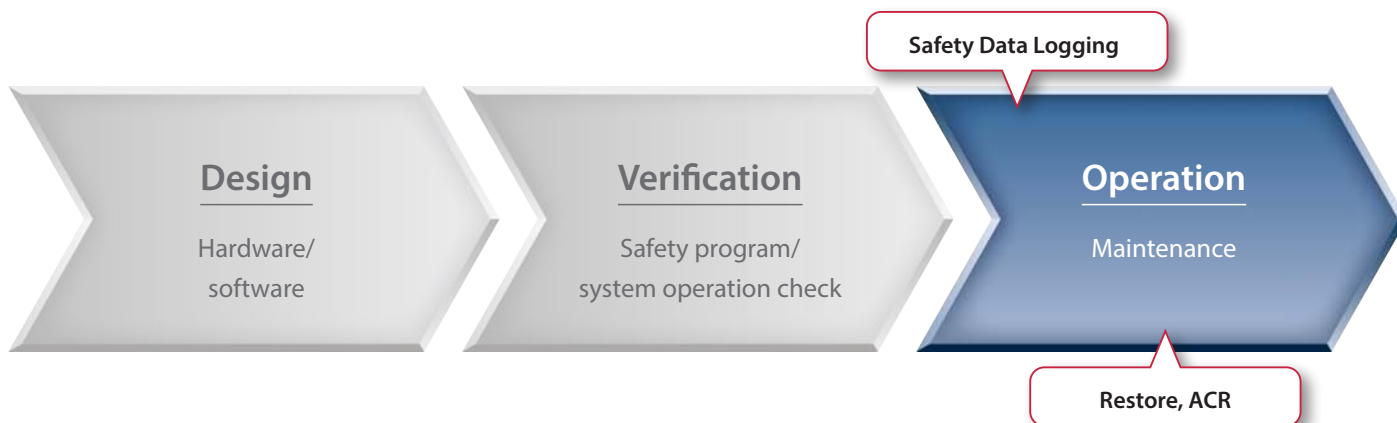

## Operation Minimize system downtime

### Safety Data Logging

An SD memory card containing logging settings is used for Safety Data Logging.

When start trigger conditions are met, the specified device variables and exposed variables can be logged in a chronological order and output to the SD memory card. This function helps to quickly identify the cause of a sudden stoppage of the system and determine preventive measures.



## Operation Reduce maintenance work

### Safety Unit Restore

Programs and settings can be stored on an SD memory card inserted into the communication control unit. When the safety CPU unit is replaced, the stored programs and settings can be easily copied to a new unit using the SD memory card.



### ACR (Automatic Configuration Restart)

When replacing a safety I/O unit, just remove the old unit and mount a new one. The setting data is automatically downloaded. When replacing a safety I/O terminal, remove the memory cassette from the old terminal and install it into the new terminal to inherit the settings. No software is required. (See page 34)

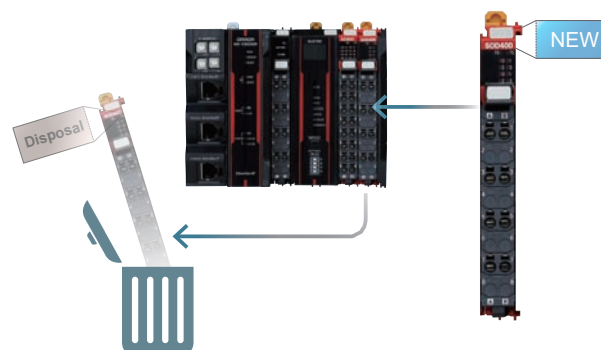

- Sysmac is a trademark or registered trademark of OMRON Corporation in Japan and other countries for OMRON factory automation products.
- STI is a trademark or registered trademark of OMRON Corporation in Japan and other countries.
- Windows is a registered trademark of Microsoft Corporation in the USA and other countries.
- EtherCAT® is a registered trademark and patented technology, licensed by Beckhoff Automation GmbH, Germany.
- Safety over EtherCAT® is a registered trademark and patented technology, licensed by Beckhoff Automation GmbH, Germany.
- EtherNet/IP™, CIP Safety™, CompoNet™, and DeviceNet™ are trademarks of ODVA.
- The SD and SDHC logos are trademarks of SD-3C, LLC.
- Other company names and product names in this document are the trademarks or registered trademarks of their respective companies.
- Microsoft product screen shot(s) reprinted with permission from Microsoft Corporation.
- The product photographs and figures that are used in this catalog may vary somewhat from the actual products.
- Some images are used under license from Shutterstock.com.

## Ordering Information

### Communication Control Unit



Unit type	Appearance	Supported communications protocol	Number of communications connectors	Network variables	Unit version	Model
Communication Control Unit		EtherNet/IP *1	3	2 *2	Ver. 1.01	<b>NX-CSG320</b>

**Note:** One NX-END02 End Cover is provided with the NX-CSG320 Communication Control Unit.

\*1. Routing of the CIP Safety protocol is supported.

\*2. PORT1 is an independent port. PORT2A and PORT2B are the ports with a built-in Ethernet switch.

### Safety CPU Units

Unit type	Appearance	Specifications				Unit version	Model
		Maximum number of safety I/O points	Program capacity	Number of safety I/O connections	I/O refreshing method		
Safety CPU Unit (NX-SL5□□□)		1024 points	2048 KB	128	Free-Run refreshing	Ver. 1.4	<b>NX-SL5500</b>
		2032 points	4096 KB	254	Free-Run refreshing	Ver. 1.4	<b>NX-SL5700</b>



### GI-S-series safety I/O terminals

Unit type	Appearance	Specifications							Unit version	Model
		Corresponding communication protocol	Number of connectors	Number of networks	Number of safety input points	Number of test output point	Number of safety output points	OMRON special safety input devices *2		
Safety I/O Terminals		EtherNet	2	1 *1	12 points	12 points	4 points	Cannot be connected.	Ver. 1.0	<b>GI-SMD1624</b>
					12 points	12 points	---	Cannot be connected.	Ver. 1.0	<b>GI-SID1224</b>

\*1. PORT1 and PORT2 are ports with switching hub.

\*2. See notes (\*1 to 3) in *Safety Input Units* for details.

### Safety Input Units

Unit type	Appearance	Specifications							Unit version	Model
		Number of safety input points	Number of test output points	Internal I/O common	Rated input voltage	OMRON special safety input devices *1	Number of safety slave connections	I/O refreshing method		
Safety Input Units		4 points	2 points	Sinking inputs (PNP)	24 VDC	Can be connected.	1	Free-Run refreshing	Ver. 1.1	<b>NX-SIH400</b>
		8 points	2 points	Sinking inputs (PNP)	24 VDC	Cannot be connected.	1	Free-Run refreshing	Ver. 1.0	<b>NX-SID800</b>

\*1. The following OMRON special safety input devices can be connected directly without a special controller.



For detail of connectable OMRON special safety input devices, refer to *NX-series User's Manual Safety Control Unit/Communication Control Unit* (Cat. No. Z395).

Type	Model and corresponding PL and safety category
OMRON Single-beam Safety Sensors	E3ZS
OMRON Non-contact Door Switches *2	D40Z D40A
OMRON Safety Mats	UM, UMA *3
OMRON Safety Edges	SGE (4-wire connection)

\*2. The D41D High-Coded Non-Contact Safety Door Switch, which requires no dedicated controller, can be connected directly to the GI-S Series, NX-SIH400, and NX-SID800.

\*3. The UM Series was discontinued at the end of June 2019.

## Safety Output Units

Unit type	Appearance	Specifications						Unit version	Model
		Number of safety output points	Internal I/O common	Maximum load current	Rated voltage	Number of safety slave connections	I/O refreshing method		
Safety Output Units		2 points	Sourcing outputs (PNP)	2.0 A/point, 4.0 A/Unit at 40°C, and 2.5 A/Unit at 55°C The maximum load current depends on the installation orientation and ambient temperature.	24 VDC	1	Free-Run refreshing	Ver. 1.0	<b>NX-SOH200</b>
		4 points	Sourcing outputs (PNP)	0.5 A/point and 2.0 A/Unit	24 VDC	1	Free-Run refreshing	Ver. 1.0	<b>NX-SOD400</b>

## Automation Software Sysmac Studio

Please purchase a DVD and required number of licenses the first time you purchase the Sysmac Studio. DVDs and licenses are available individually. Each model of licenses does not include any DVD.

Product name	Specifications	Number of licenses	Media	Model
<b>Sysmac Studio Standard Edition</b> Ver. 1.□□	The Sysmac Studio is the software that provides an integrated environment for setting, programming, debugging and maintenance of machine automation controllers including the NJ/NX-series CPU Units, NY-series Industrial PC, EtherCAT Slave, and the HMI.	--- (Media only)	Sysmac Studio 32-bit edition DVD	<b>SYSMAC-SE200D</b>
	Sysmac Studio runs on the following OS. *2 Windows 7(32-bit/64-bit version)/8(32-bit/64-bit version)/8.1(32-bit/64-bit version)/10(32-bit/64-bit version)/11(64-bit version) For details, refer to your local OMRON website.	--- (Media only)	Sysmac Studio 64-bit edition DVD	<b>SYSMAC-SE200D-64</b>
	The Sysmac Studio Standard Edition DVD includes Support Software to set up EtherNet/IP Units, DeviceNet slaves, Serial Communications Units, and Support Software for creating screens on HMIs (CX-Designer). For details, refer to your local OMRON website.	1 license *3	---	<b>SYSMAC-SE201L</b>
<b>Sysmac Studio Safety Edition *4</b> Ver. 1.□□	Sysmac Studio Safety Edition is a license including necessary setting functions for the safety control system. *This product is a license only. You need the Sysmac Studio Standard Edition DVD media to install it.	1 license	---	<b>SYSMAC-FE001L</b>

**Note:** For details of the Automation Software Sysmac Studio, refer to your local OMRON website.

\*1. The Sysmac Studio Standard Edition License (SYSMAC-SE2□□L) includes functions that the Safety Edition (SYSMAC-FE001L) provides. The Communication Control Unit can be used with the Sysmac Studio version 1.24 or higher.

\*2. Model "SYSMAC-SE200D-64" runs on Windows 10 (64bit) or higher.

\*3. Multi licenses are available for the Standard Edition (3, 10, 30, or 50 licenses).

\*4. The Safety Edition can be used with a safety control system using the Communication Control Unit or EtherNet/IP Coupler Unit.

## Optional Products

### SD Memory Card

Product name	Specification	Model
SD Memory Card	Flash Memory, 2 GB	<b>HMC-SD292</b>
	Flash Memory, 4 GB	<b>HMC-SD492</b>

**Note:** Refer to the HMC-SD292/492/1A2 datasheet for details on the memory card.

### Unit/Terminal Block Coding Pins

Product Name	Specification	Model
Unit/Terminal Block Coding Pins	For 10 Units (Terminal Block: 30 pins, Unit: 30 pins)	<b>NX-AUX02</b>

### Terminal Block

Product name	Specification				Model
	No. of terminals	Terminal number indications	Ground terminal mark	Terminal current capacity	
Terminal Block	8	A/B	Provided	10 A	<b>NX-TBC082</b>
	8	A/B	None	10 A	<b>NX-TBA082</b>
	16	A/B	None	10 A	<b>NX-TBA162</b>

## NX-series NX102 CPU Units

For details on NX-series NX102 CPU Units, refer to the *NX1 Machine Automation Controller Datasheet* (Cat. No. P130).

# Terms and Conditions Agreement

## **Read and understand this catalog.**

Please read and understand this catalog before purchasing the products. Please consult your OMRON representative if you have any questions or comments.

## **Warranties.**

- (a) Exclusive Warranty. Omron's exclusive warranty is that the Products will be free from defects in materials and workmanship for a period of twelve months from the date of sale by Omron (or such other period expressed in writing by Omron). Omron disclaims all other warranties, express or implied.
- (b) Limitations. OMRON MAKES NO WARRANTY OR REPRESENTATION, EXPRESS OR IMPLIED, ABOUT NON-INFRINGEMENT, MERCHANTABILITY OR FITNESS FOR A PARTICULAR PURPOSE OF THE PRODUCTS. BUYER ACKNOWLEDGES THAT IT ALONE HAS DETERMINED THAT THE PRODUCTS WILL SUITABLY MEET THE REQUIREMENTS OF THEIR INTENDED USE.

Omron further disclaims all warranties and responsibility of any type for claims or expenses based on infringement by the Products or otherwise of any intellectual property right. (c) Buyer Remedy. Omron's sole obligation hereunder shall be, at Omron's election, to (i) replace (in the form originally shipped with Buyer responsible for labor charges for removal or replacement thereof) the non-complying Product, (ii) repair the non-complying Product, or (iii) repay or credit Buyer an amount equal to the purchase price of the non-complying Product; provided that in no event shall Omron be responsible for warranty, repair, indemnity or any other claims or expenses regarding the Products unless Omron's analysis confirms that the Products were properly handled, stored, installed and maintained and not subject to contamination, abuse, misuse or inappropriate modification. Return of any Products by Buyer must be approved in writing by Omron before shipment. Omron Companies shall not be liable for the suitability or unsuitability or the results from the use of Products in combination with any electrical or electronic components, circuits, system assemblies or any other materials or substances or environments. Any advice, recommendations or information given orally or in writing, are not to be construed as an amendment or addition to the above warranty.

See <http://www.omron.com/global/> or contact your Omron representative for published information.

## **Limitation on Liability; Etc.**

OMRON COMPANIES SHALL NOT BE LIABLE FOR SPECIAL, INDIRECT, INCIDENTAL, OR CONSEQUENTIAL DAMAGES, LOSS OF PROFITS OR PRODUCTION OR COMMERCIAL LOSS IN ANY WAY CONNECTED WITH THE PRODUCTS, WHETHER SUCH CLAIM IS BASED IN CONTRACT, WARRANTY, NEGLIGENCE OR STRICT LIABILITY.

Further, in no event shall liability of Omron Companies exceed the individual price of the Product on which liability is asserted.

## **Suitability of Use.**

Omron Companies shall not be responsible for conformity with any standards, codes or regulations which apply to the combination of the Product in the Buyer's application or use of the Product. At Buyer's request, Omron will provide applicable third party certification documents identifying ratings and limitations of use which apply to the Product. This information by itself is not sufficient for a complete determination of the suitability of the Product in combination with the end product, machine, system, or other application or use. Buyer shall be solely responsible for determining appropriateness of the particular Product with respect to Buyer's application, product or system. Buyer shall take application responsibility in all cases.

NEVER USE THE PRODUCT FOR AN APPLICATION INVOLVING SERIOUS RISK TO LIFE OR PROPERTY OR IN LARGE QUANTITIES WITHOUT ENSURING THAT THE SYSTEM AS A WHOLE HAS BEEN DESIGNED TO ADDRESS THE RISKS, AND THAT THE OMRON PRODUCT(S) IS PROPERLY RATED AND INSTALLED FOR THE INTENDED USE WITHIN THE OVERALL EQUIPMENT OR SYSTEM.

## **Programmable Products.**

Omron Companies shall not be responsible for the user's programming of a programmable Product, or any consequence thereof.

## **Performance Data.**

Data presented in Omron Company websites, catalogs and other materials is provided as a guide for the user in determining suitability and does not constitute a warranty. It may represent the result of Omron's test conditions, and the user must correlate it to actual application requirements. Actual performance is subject to the Omron's Warranty and Limitations of Liability.

## **Change in Specifications.**

Product specifications and accessories may be changed at any time based on improvements and other reasons. It is our practice to change part numbers when published ratings or features are changed, or when significant construction changes are made. However, some specifications of the Product may be changed without any notice. When in doubt, special part numbers may be assigned to fix or establish key specifications for your application. Please consult with your Omron's representative at any time to confirm actual specifications of purchased Product.

## **Errors and Omissions.**

Information presented by Omron Companies has been checked and is believed to be accurate; however, no responsibility is assumed for clerical, typographical or proofreading errors or omissions.

# OMRON's Products Support IoT for Control Panels and Production Lines



Safety I/O Unit  
NX-SI/SO Datasheet

Cat. No. F123



Safety CPU Unit  
NX-SL5 Datasheet

Cat. No. F124



Communication  
Control Unit  
NX-CSG Datasheet

Cat. No. F125



Safety I/O Terminal  
GI-S Series Datasheet

Cat. No. F126



NX-series  
I/O System Brochure

Cat. No. R183

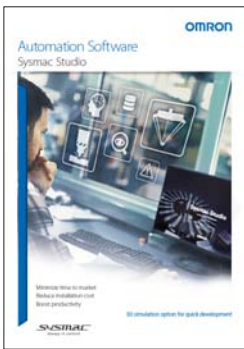

Automation Software  
Sysmac Studio  
Brochure

Cat. No. P138



Automation Software  
Sysmac Studio Ver.1 Datasheet

**Note: Do not use this document to operate the Unit.**

**OMRON Corporation Industrial Automation Company**  
Kyoto, JAPAN

Contact : [www.ia.omron.com](http://www.ia.omron.com)

## Regional Headquarters

**OMRON EUROPE B.V.**  
Wegalaan 67-69, 2132 JD Hoofddorp  
The Netherlands  
Tel: (31) 2356-81-300 Fax: (31) 2356-81-388

**OMRON ELECTRONICS LLC**  
2895 Greenspoint Parkway, Suite 200  
Hoffman Estates, IL 60169 U.S.A.  
Tel: (1) 847-843-7900 Fax: (1) 847-843-7787

**OMRON ASIA PACIFIC PTE. LTD.**  
438B Alexandra Road, #08-01/02 Alexandra  
Technopark, Singapore 119968  
Tel: (65) 6835-3011 Fax: (65) 6835-2711

**OMRON (CHINA) CO., LTD.**  
Room 2211, Bank of China Tower,  
200 Yin Cheng Zhong Road,  
PuDong New Area, Shanghai, 200120, China  
Tel: (86) 21-6023-0333 Fax: (86) 21-5037-2388

**Authorized Distributor:**

©OMRON Corporation 2018-2023 All Rights Reserved.  
In the interest of product improvement,  
specifications are subject to change without notice.

**CSM\_1\_18**  
Cat. No. F104-E1-11 0223 (0618)